

# KJ-1250

# Water Jetter

OPERATOR'S  
MANUAL

## IMPORTANT

For your own safety, before assembling and operating this unit, read this Operator's Manual carefully and completely. Learn the operation, applications and potential hazards peculiar to this unit.

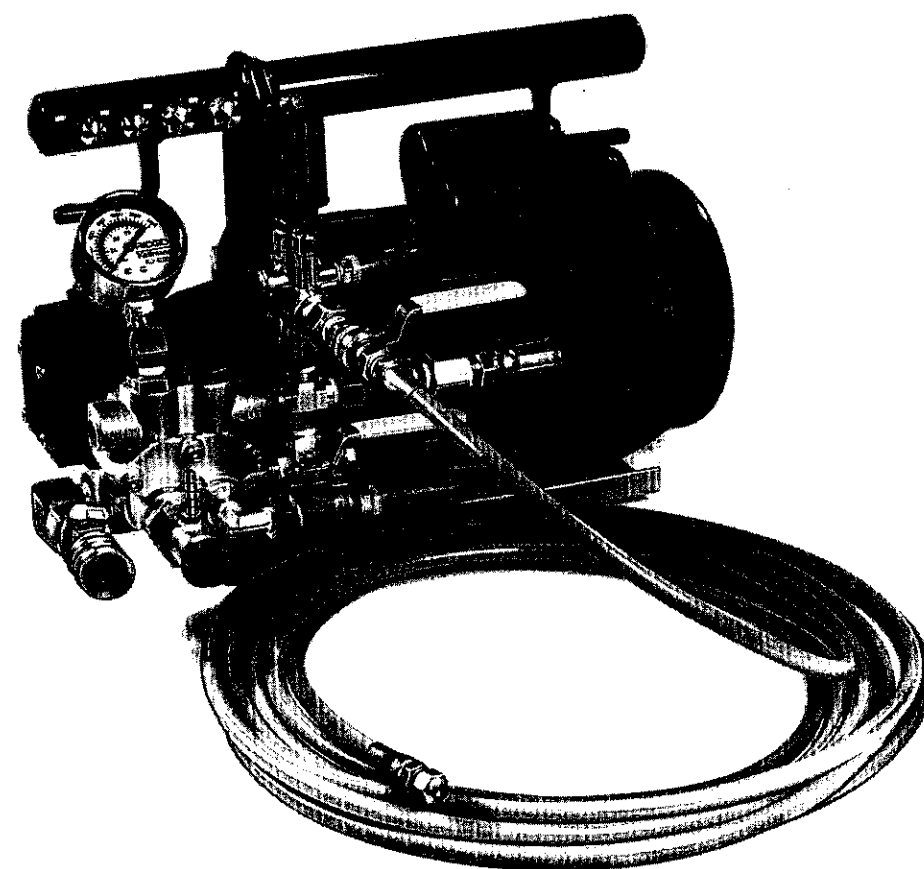

**RIDGID** | Kollmann

FOR YOUR FILE

## PUBLICATIONS NOTICE

Date: June 9, 1992 RE: KJ-1250 Manual — Form No. KJ1250-WJ-1091 — 278-086-311

*The attached literature has just been printed and sent to you for the express purpose of providing the latest information for your file. This supercedes all previous editions.*

**Reason For Distribution:**

New  
 Revision  
Type:  Parts  Pictorial  Copy

Pages Affected: \_\_\_\_\_

Additional copies of attached literature can be ordered by writing to Ridge Tool Company, c/o Graphics Center, 400 Clark Street, Elyria, Ohio 44036-2023. All requests must include literature form number, product name, quantity desired and return address.

Signed

**Table of Contents**

**Page**

**Description, Specifications and Standard Equipment** .....1  
**Safety Information**.....2 and 3  
 General Safety .....2  
 Personal Safety.....2  
 Electrical Safety .....2 and 3  
 Work Area Safety .....3  
 Machine Safety .....3  
 Machine Maintenance .....4  
**Machine Set-Up** .....4 and 5  
**Start-up and Operation**.....6 through 9  
 Pulse Control Valves .....6  
 Start-up .....7  
 Negotiating Bends and Traps.....7  
 Using the Pulse Mode to Negotiate Bends/Traps .....8  
 Especially Stubborn Bends/Traps .....8  
 Encountering Blockages .....8  
 Jetter Nozzle Selection .....8  
 "Jet-Cleaning" or "Jetting" the Line.....8 and 9  
 Jetter Hose Selection .....9  
**Washer Operation** .....9  
**Maintenance Instructions** .....9  
**Lubrication** .....9  
**Inlet Filter Screen** .....9  
**Jetter Nozzle Orifice**.....9  
**Troubleshooting**.....10  
**Lifetime Warranty** .....Rear Cover

**Description, Specifications and Standard Equipment**

**Description**

The KJ-1250 Jetter is a compact, portable machine designed to clear grease and sludge out of 1 1/4" to 4" drain lines. It can be either hand carried or combined with a two wheel cart and hose reel for easy transport.

**Specifications**

Line Capacity.....Recommended for 1 1/4" to 4" drain lines through 150 feet.

**Motor:**

Type .....115V/60 Hz TEFC  
 240V/50 Hz version available on request.

Rating .....1 1/2 Hp @ 1725 RPM.

**Pump:**

Type .....Duplex Plunger  
 Pressure (rated).....1500 PSI  
 Flow Rate (rated).....1.5 GPM  
 Weight (jetter only).....70 lbs.

**Machine Options**

Model No.	Description
KJ-1250SE	KJ-1250 Jetter (1 each) Model H-2001, H-2002 Jetter Nozzles (1 each) Model H-2011, H-2012 Jetter Nozzles 1/4" x 35' Jet Trap Hose
KJ-1250-1	KJ-1250 Jetter (1 each) Model H-2001, H-2002, and H-2003 Jetter Nozzles (1 each) Model H-2011, H-2012, and H-2013 Jetter Nozzles 1/4" x 25' Jet Trap Hose 1/2" x 75' Jet Hose (1) Jetter Nozzle Cleaning Tool
KJ-1250-2	KJ-1250 Jetter w/Pulse Control Valve and Chemical Wash Injector System (1) Wash Wand (1 each) Model H-2001, H-2002, and H-2003 Jetter Nozzles (1 each) Model H-2011, H-2012, and H-2013 Jetter Nozzles 1/4" x 25' Jet Trap Hose 1/2" x 75' Jet Hose (1) Jetter Nozzle Cleaning Tool

Model No.	Description
KJ-1250-3	KJ-1250 Jetter (1 each) Model H-2001, H-2002, and H-2003 Jetter Nozzles (1 each) Model H-2011, H-2012, and H-2013 Jetter Nozzles 1/4" x 25' Jet Trap Hose 1/2" x 75' Jet Hose (1) Model H-20 Cart w/200' Capacity Hose Reel 9/16" x 100' Jet Hose (1) Jetter Nozzle Cleaning Tool
KJ-1250-4	KJ-1250 Jetter w/Pulse Control Valve and Chemical Wash Injector System (1) Wash Wand (1 each) Model H-2001, H-2002, and H-2003 Jetter Nozzle (1 each) Model H-2011, H-2012, and H-2013 Jetter Nozzle 1/4" x 25' Jet Trap Hose 1/2" x 75' Jet Hose (1) Jetter Nozzle Cleaning Tool (1) Model H-20 Cart w/200' Capacity Hose Reel 9/16" x 100' Jet Hose

**Accessories**

Model No.	Description
H-20	Cart w/Hose Reel and 9/16" x 100' Hose
H-21	Nozzle Cleaning Tool
H-22	Pulse Control Valve Assembly
H-23	Chemical Wash Injector System
H-24	Wash Wand
H-25	Winterizing Kit
H-20VAC	Wet/Dry Vacuum

**Jet Hose**

Model No.	Description
H-1425	1/4" x 25' Jet Trap Hose
H-1435	1/4" x 35' Jet Trap Hose
H-1450	1/4" x 50' Jet Trap Hose
H-1475	1/4" x 75' Jet Trap Hose
H-1400	1/4" x 100' Jet Trap Hose
H-1250	1/2" x 50' Jet Hose
H-1275	1/2" x 75' Jet Hose
H-1200	1/2" x 100' Jet Hose
H-975	9/16" x 75' Jet Hose
H-900	9/16" x 100' Jet Hose
H-915	9/16" x 150' Jet Hose
H-920	9/16" x 200' Jet Hose

## Safety Information

### Warning: Read All Instructions

The operator's manual contains safety information and instructions for your protection against serious injuries including:

Electrical shock or burns from contact with wires, motor or other power drive parts;

Eye injuries, including being blinded by the water jet or thrown debris.

### General Safety



Read and follow the safety information and instructions in the operator's manual.

Read and follow the safety labels on the machine.

Know the location and functions of all controls before using machine.

If a connection is made to a potable water system, the system should be protected against backflow in accordance with all local codes and ordinances.

**WARNING**

**Warning:** Electrical shock can occur if machine is not properly grounded or maintained.

- Plug cord into grounded three-prong receptacle.
- Wear rubber boots in wet areas.
- Wear safety glasses.
- Test Ground Fault Circuit Interrupter (G.F.C.I.) to insure proper operation.
- Do not use with damaged or worn electrical cords.
- Be sure end of hose is not allowed to whip.

### Personal Safety

1. Wear snug fitting clothes, safety shoes and safety glasses. Cover up or tie up long hair. Do not wear loose clothing, unbuttoned jackets, loose sleeve cuffs, neckties, rings, watches or jewelry.

2. Keep good footing and balance. Do not overreach.
3. Do not operate machine when you are tired.
4. Be very careful when cleaning drains where cleaning compounds have been used. Wear gloves and avoid direct contact of skin and especially eyes and facial area, as serious burns can result from some drain cleaning compounds.

## Electrical Safety

### Grounding Instructions

Machine must be grounded. If it should malfunction or breakdown, grounding provides a path of least resistance for electric current to reduce the risk of electrical shock.

Water Jetter is equipped with a cord having an equipment-grounding conductor and a grounding plug. The plug must be plugged into an appropriate outlet that is properly installed and grounded in accordance with all local codes and ordinances.

If your unit is for use on less than 150 volts, it has a 120V plug. If it is for use on 150 to 250 volts, it has a 230V plug.

**Danger: Improper connection of the equipment grounding conductor can result in a risk of electrical shock. Check with a qualified electrician or service person if you are in doubt as to whether the outlet is properly grounded. Do not modify the plug provided with the product. If it will not fit the outlet, have a proper outlet installed by a qualified electrician.**

Connect the machine to an A.C. power supply that matches the nameplate specifications. Do not use D.C. power.

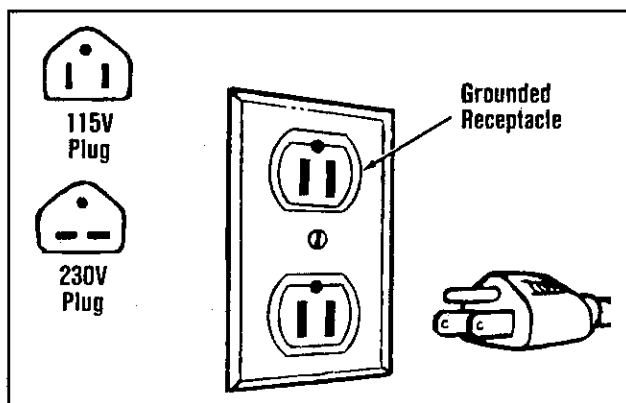

Machine Grounding Instructions

## Extension Cords

Use only 3-wire extension cords that have 3-prong grounding type plugs and 3 pole cord connectors that accept the machine's plug.

Use only extension cords that are intended for outdoor use. These extension cords are identified by a marking "Acceptable for use with outdoor appliances; store indoors while not in use".

Use only extension cords having an electrical rating not less than the rating of the product. Refer to the following chart of recommended extension cord sizes.

Do not use damaged extension cords. Examine before using and replace or repair damaged, frayed, broken or worn cords.

Length of Cord	Wire Size Required	
	120V	230V
50 feet	12	14
100 feet	10	12
150 feet	—	10
200 feet	—	8
300 feet	—	8
400 feet	—	6

Extension Cord Chart

Do not abuse extension cords. Keep cord from heat, oil, and sharp edges. Do not yank on any cord to disconnect.

Extension cords are not recommended unless they are plugged into a Ground-Fault Interrupter (G.F.I.) found in circuit boxes or outlet receptacles.

Always disconnect the extension cord from the receptacle before disconnecting the product from the extension cord.

Warning: To reduce the risk of electrical shock, keep all connections dry and off the ground. Do not touch plug with wet hands.

### Ground-Fault Circuit-Interrupter (G.F.C.I.)

1. Water Jetter is provided with a ground-fault circuit-interrupter (G.F.C.I.) built into the power supply cord. This device provides additional protection from the risk of electrical shock.

Before using, test the Ground-Fault Circuit-Interrupter (G.F.C.I.) to insure it is operating correctly.

Should replacement of the cord become necessary, use only identical replacement parts that include G.F.C.I. protection.

Do not abuse cord or Ground-Fault Circuit-Interrupter (G.F.C.I.). Keep cord from heat, oil, and sharp edges.

2. Unplug power cord when adjusting, servicing or changing accessories.
3. Use rubber gloves and rubber boots to insulate against possible electrical shock.

### Work Area Safety

1. Keep children and visitors out of work area. If visitors must be in area, keep them far away from the machine and extension cords.
2. Keep work area clean, uncluttered and well lighted.
3. Clear machine of all objects such as wrenches or keys before turning machine ON.
4. Do not operate in gaseous or explosive atmospheres. Motor's spark may ignite fumes.

### Machine Safety

1. Do not operate above 1250 psi and 165°F.
2. Never permit the end of hose to rotate out of the pipe being cleaned.
3. Do not force nozzle. It will do the job better and safer at the rate for which it was intended.
4. Avoid accidental starting. Be sure switch is OFF when plugged in.
5. Do not abuse cord or Ground-Fault Circuit-Interrupter (G.F.C.I.). Keep cord from heat, oil and sharp edges.
6. Store idle equipment. When not in use, jetter should be stored in a dry, high or locked up place out of the reach of children.
7. Check for damaged parts before using. Check switches, valves, hoses and nozzles to insure proper operation. Have damaged parts repaired or replaced by an Authorized Service Center.
8. Do not use tool if Ground-Fault Circuit-Interrupter (G.F.C.I.), ON/OFF switch, or ground plug is broken.
9. Use recommended accessories. Refer to operator's manual.

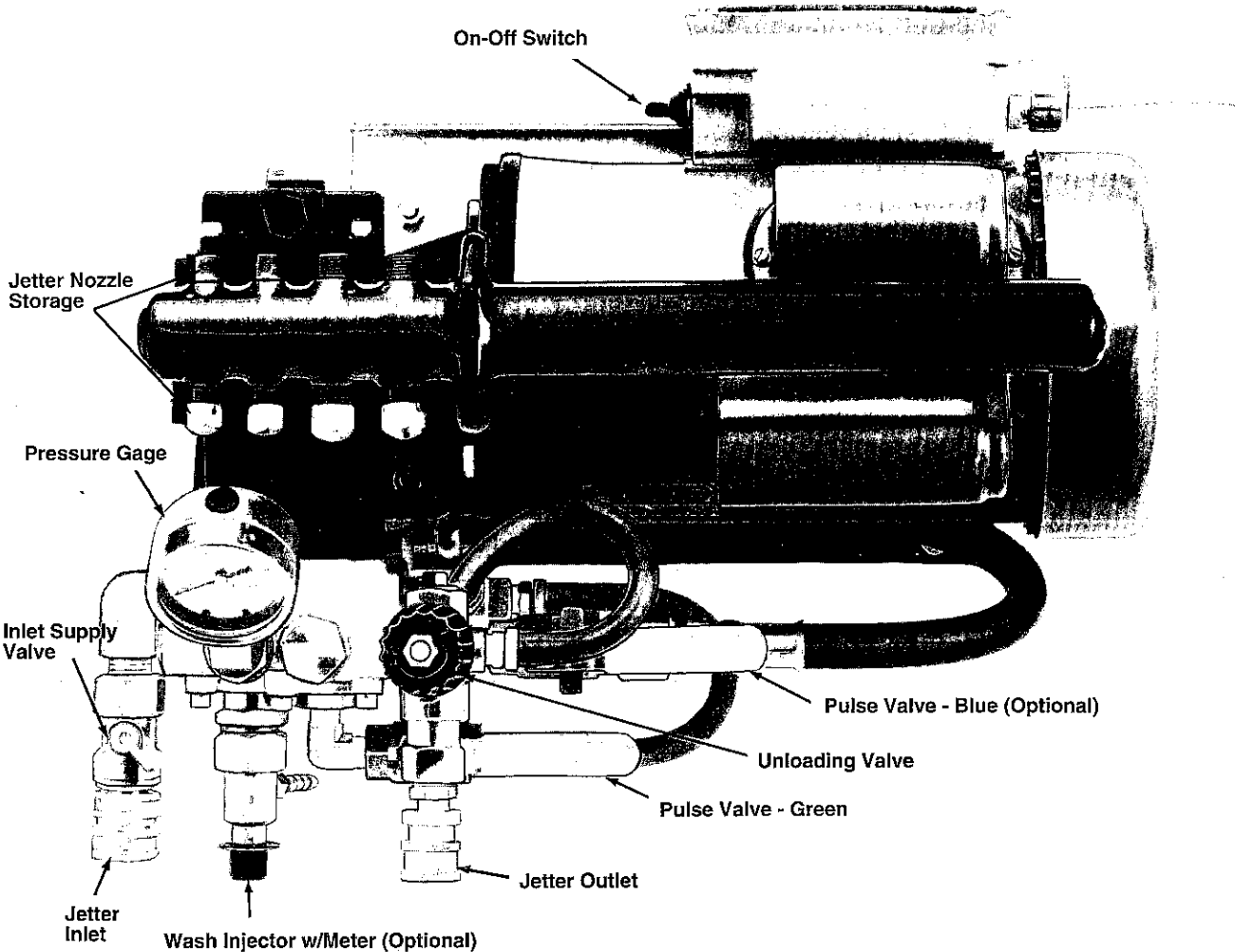

Figure 1

**Machine Maintenance**

1. Follow instructions for lubricating and changing accessories.
2. Inspect machine cord. Replace damaged, frayed, broken or worn cord.
3. Inspect extension cords. Repair or replace damaged, frayed, broken or worn cords.
4. Keep handles dry and clean. Keep free from oil and grease.

**NOTE: SAVE THESE INSTRUCTIONS!**

**Machine Set-Up**

**Note:** Before operating jetter, check the oil level. If it is low, fill with SAE 30 weight non-detergent oil.

1. Connect the water supply line to the jetter inlet and close the inlet supply valve. (Figure 2)
2. Connect the other end of the water supply line to the water faucet and turn the faucet on.

**Caution:** Hot water improves the jetter's cleaning action, particularly when clearing grease blockages. However, limit water temperature to below 165°F.

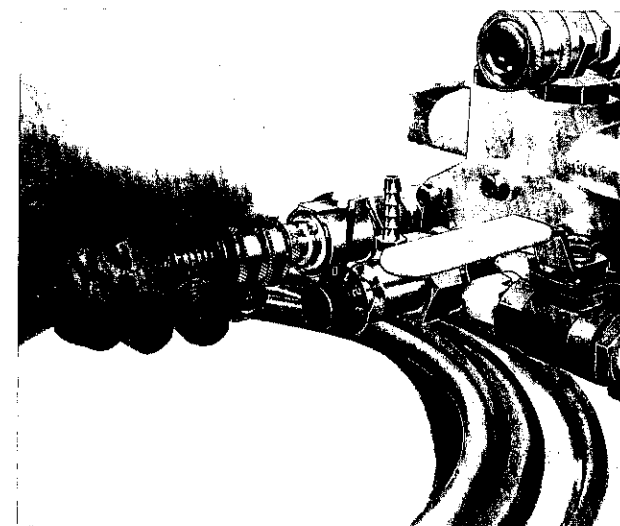

Figure 2. Connect water supply line to jetter. Close inlet supply valve (shown in closed position.)

3. Plug the power cord into a grounded 115V receptacle. Test the GFCI for proper operation before operating the jetter.

**Warning:** To reduce the risk of electrical shock, keep all connections dry and off the ground. Do not touch plug with wet hands.

4. Connect a jetter hose to the jetter's outlet port. (Figure 3)
  - 4a. If you are using a hose mounted on the hose reel, connect the reel's supply line to the outlet port. (See inset, Figure 3)
5. Attach a jetter nozzle to the jet hose. Hand tighten for a snug fit. Over-tightening can interfere with water flow through the thrusters causing reduced flow and poor performance. (Figure 4)
6. Insert the jet hose into the line several feet.
7. Open the inlet supply valve and verify that water flows freely through the nozzle.

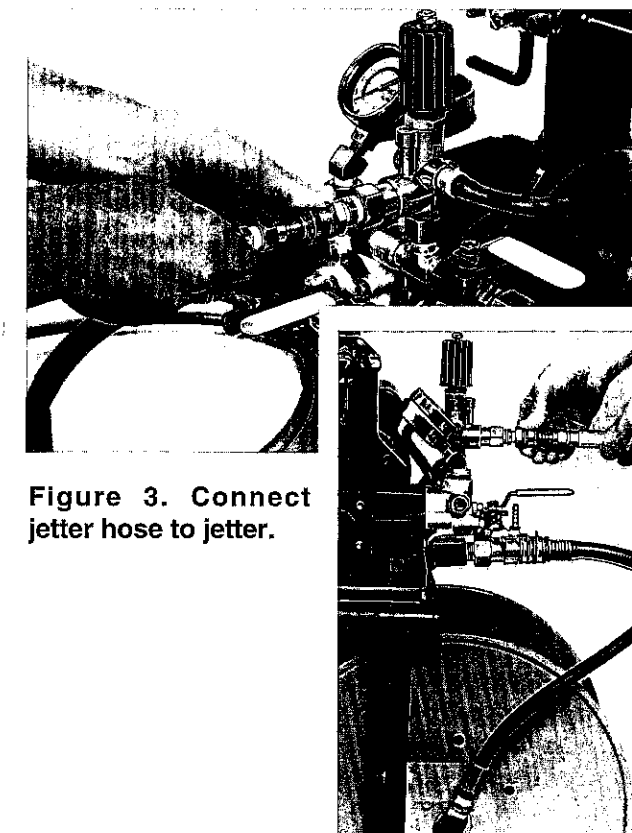

Figure 3. Connect jetter hose to jetter.

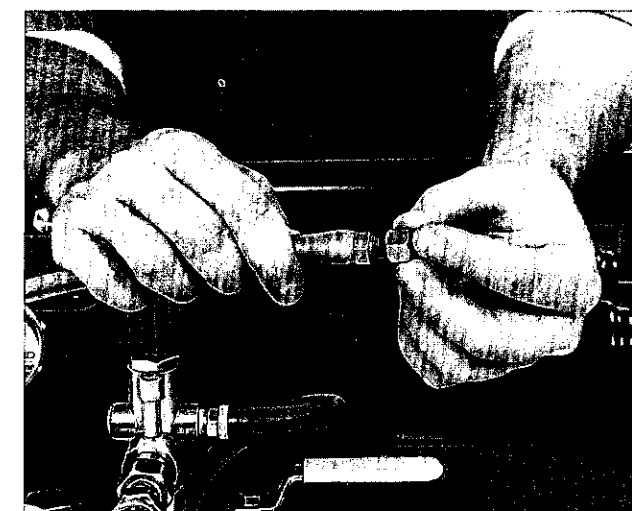

Figure 4. Attach a jetter nozzle to the jetter hose; hand tighten for a snug fit.

## Start-Up and Operation

### Pulse Control Valves

Every KJ-1250 jetter comes equipped with a green pulse control valve. Models featuring the pressure washing package include a second blue pulse

control valve. For optimum jetter performance, you must understand the proper use of the pulse control valves.

**At Start-Up**, both the green and blue valves must be in the "OFF" position. (Figure 5)

**Note:** Do not adjust the jetter to maximum operating pressure with either pulse valves "ON". Doing so will cause the motor to overheat and shut-down.

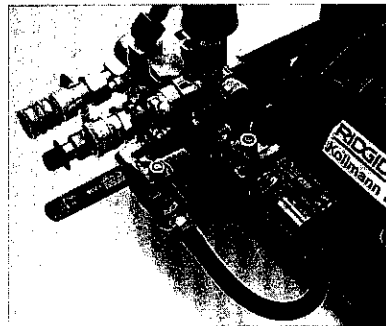

Figure 5. At start-up both green and blue valves are "OFF".

**For Normal Jetting Operation**, close the blue pulse valve to the "ON" position—leave the green pulse valve "OFF". (See Figure 6) There will be a slight drop in jetting pressure—that is normal.

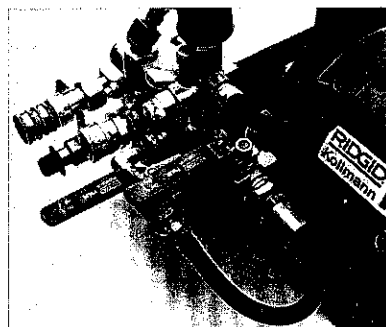

Figure 6. For normal jetting, the green valve is "OFF" and the blue valve is "ON".

**To negotiate bends and traps**, open the green pulse valve to the "ON" position (Figure 7). With both pulse valves "ON", the jetter generates maximum pulse and the pressure drops to about 650 PSI.

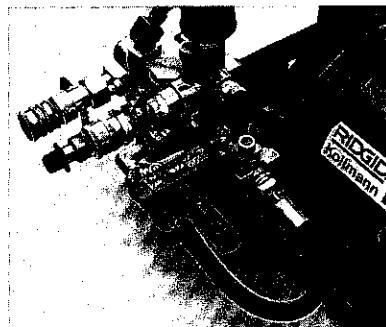

Figure 7. To negotiate bends and traps, both valves are "ON" for maximum pulse.

**For Pressure Washing**, both the green and blue pulse valves must be "OFF" (Figure 8). At these valve settings, the jetter generates maximum pressure for power washing.

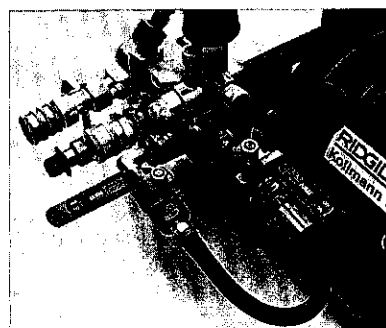

Figure 8. For power washing both valves are "OFF" for maximum pressure.

### Start-Up

1. Close the green pulse valve to the "OFF" position. Open the blue pulse valve to the "OFF" position.
2. Turn the jetter switch "ON" and adjust the unloading valve so that the pressure gage shows 1250 PSI. At this pressure, the jetter draws approximately 12.5 amps when supplied with 115 volt A/C current. (Figure 9)

**Note:** Do not adjust the jetter to maximum operating pressure with either pulse valves "ON". Doing

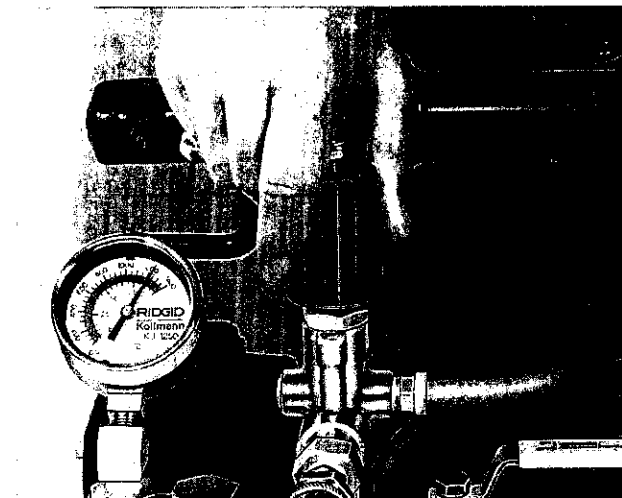

Figure 9. Adjust the unloading valve so that the pressure gauge shows 1250 PSI.

so will cause the motor to overheat and shut-down.

3. If the jetter will not generate 1250 PSI:
  - Make sure the water faucet is completely open and the inlet supply valve is open.
  - Check the pulse control valve settings. Make certain both are off.
  - Check the filter screen at the inlet port to the jetter. Make certain it is clear of debris.
  - Cycle the pulse valves "ON" and "OFF" several times while the jetter is running to clear any trapped air in the system.
4. As soon as the jetter is operating smoothly at 1250 PSI, close the blue pulse valve to the "ON" position. The jetter nozzle should advance down the line unaided.

5. You can speed the jet hose advance by guiding it into the line by hand. This will be necessary when using a jetter hose mounted on a hose reel.

**Caution:** If at any time during the jetting process the pressure oscillates between 0 and 1250 PSI stop the jetter:

- Remove the jetter nozzle and check the thrusters. They are probably blocked. Clean them with the nozzle cleaning tool by pushing the proper size wire completely through each thruster orifice.
- If the problem persists, remove the nozzle and insert the hose into the drain. Restart the jetter and cycle the valves on and off several times to flush the system of any trapped air or debris that could be hampering the unit's operation.

### Negotiating Bends and Traps

When the jetter nozzle encounters a bend, its advance will usually slow or stop. To continue the nozzle's advance, use the slight bend or "SET" at the end of the hose to direct the nozzle around the bend. (See Figure 10)

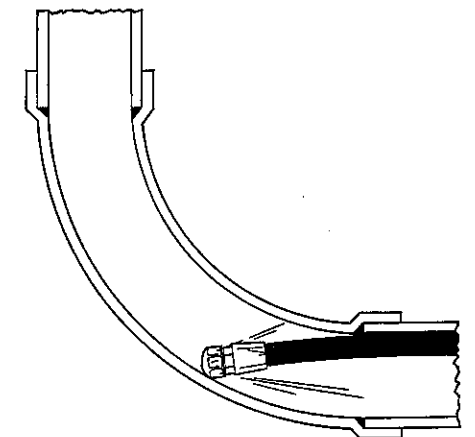

Figure 10.

### If the Hose Advance Stops or Slows

1. Pull back on the hose ever so slightly and rotate a quarter to a half turn. Then, play it forward.
2. Repeat until the "SET" at the end of the hose aligns with and moves through the bend(s). (See Figure 11)

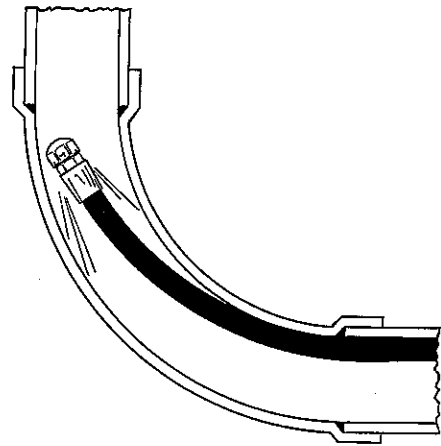

Figure 11.

### Using the Pulse Mode to Negotiate Bends/Traps

In some cases, simply rotating the hose will not be enough to negotiate a bend or trap. In these instances, put the green pulse valve in the "ON" position. In the pulse mode, the pump induces large pulsations in the jetter hose. Rotating the hose while operating in the pulse mode will normally overcome stubborn bends and traps.

**Note:** In the pulse mode, the jetter's pressure gage will read approximately 700 PSI.

Once through the bend or trap, return the pump valve to the pressure mode and continue the jetter head's advance.

### Especially Stubborn Bends/Traps

If hose rotation combined with the pulse action doesn't move the jetter through the bend or trap, try reducing the pressure to approximately 500 PSI. The reduced pressure will make the hose more flexible to negotiate the bend(s).

### Encountering Blockages

Normally, the jetter nozzle will pass right through sludge or grease blockages. More stubborn blockages may require manual manipulation of the hose combined with the pulse action of the pump.





Once through the obstruction, pass the jetter nozzle back and forth several times through that section of the line to ensure it is thoroughly cleared, then advance the nozzle several feet further down the line before retrieving the hose.

### "Jet-Cleaning" or "Jetting" the Line

The jetter's cleaning action occurs at the nozzle. The orifices or jets in the jetter nozzle direct multiple high pressure streams of water that break-up grease, sludge and soap build-up. (This same jet action produces a thrust that pushes the nozzle down the line - pulling the hose behind it.) In the pulse mode, the jetter nozzle's "punching" action helps break-up solid blockages.

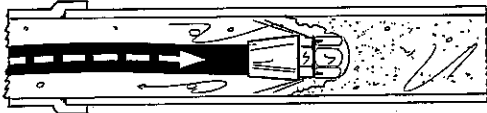
After clearing the obstruction, a final whole line cleaning occurs when the nozzle is pulled back through the line. The slower the hose is retrieved, the better the results.

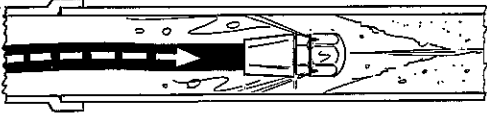
It is best to jet drain lines from downstream of the blockage. As the head retreats through the line, it brings with it the grease, sludge, etc. that caused the blockage. Also, jetting from downstream avoids the nuisance of a back-flow in a totally blocked line.

JETTER NOZZLE SELECTION		MODEL NO.		
		1/4"	1/2" & 3/16"	
		Features three jet thrusters in reverse for maximum propulsion to jet long distances. Use this nozzle for most applications.	H-2001	H-2011
		Uses three jet thrusters in reverse plus one jet pointed forward to penetrate solid grease or sludge blockages. The forward jet blasts a small hole in the blockage for the nozzle to follow. It's also very effective when jetting ice blockages.	H-2002	H-2012

It is not always practical or possible to jet from downstream. In these instances, allow more time for the jetting action to clean the pipe, and flush the line occasionally (provided it is not totally blocked). If back-flow becomes a problem, a wet/dry vacuum can be used to collect the backflow. A bilge pump can serve the same purpose.

**Note:** Since a jetter depends on high pressure water for its cleaning action, pressure losses should be minimized. Leaky fittings and hoses can cause pressure losses and poor performance. In the event of a pressure loss, refer to the troubleshooting chart on page 10.

### Jetter Hose Selection

Smaller hoses will negotiate smaller lines, but also suffer greater pressure loss per foot of hose. Consequently, larger diameter hoses can be used to jet greater distances.

**1/4" Jet Trap Hose:** Recommended for 3" and smaller drain lines. It will negotiate 2" and larger traps. The trap hose is most effective when jetting less than 75'.

**1/2" Jet Hose:** Recommended for 3" and larger drain lines. It will negotiate 4" traps. It is most effective when jetting less than 125'.

**3/16" Jet Hose:** Recommended for 4" lines and traps. It is most effective when jetting up to 150'.

### Washer Operation

Models equipped with a blue pulse valve, chemical/detergent wash injection and wash wand can be used to spray wash service trucks or vans, tools, drain cleaning machine cables, etc. To utilize the wash feature make sure both pulse valves are in the "OFF" position. Adjust system pressure with the wash wand activated. The wash wand will fit either the 1/2" or 3/16" jetter hose.

The injector meter introduces a chemical or detergent into the water flow for more effective cleaning. To use the injector:

1. Attach the pressure reducing valve to the jetter inlet.
2. Place one end of a siphon hose into the chemical/detergent's container.

3. Connect the other end to the siphoning fitting on the injector meter.
4. Adjust the meter to achieve the desired mixture of chemical in the wash. Make adjustments with the jetter running.

### Maintenance Instructions

**Warning:** Make sure machine is unplugged from electrical system before making any adjustment.

**Caution:** If any maintenance is required other than that listed below, take jetter to a RIDGID Authorized Service Center or return it to factory.

### Freezing Temperatures

**Warning:** Freezing temperatures can cause serious damage to the pump. If such storage conditions are encountered, charge the Jetter with RV Anti-Freeze. A winterizing kit that includes RV Anti-Freeze and delivery hose is available as an accessory.

### Lubrication

Before each use, check the oil level on the jetter. If it is low, fill with SAE 30 weight, non-detergent oil.

### Inlet Filter Screen

Before each use, check inlet filter screen for debris that can restrict water flow into the pump resulting in poor performance. If filter screen is dirty or clogged, remove, clean, and replace.

### Jetter Nozzle Orifice

Before each use, check the jetter nozzle orifices for debris that can block and restrict water flow. Reduced flow through the orifices can cause extreme pressure fluctuations and poor performance. If orifice is blocked, use nozzle cleaning tool to clear, remove debris.

## Troubleshooting

Symptom	Probable Cause(s)	Corrective Action
Jetter runs but produces little or no pressure.	Inadequate water supply.	Make certain water supply faucet is on.  Make certain jetter's water supply inlet valve is on.  Make certain water supply hose is clear and not kinked or collapsed.
Jetter will not adjust to full 1250 PSI operating pressure at start-up.	Green pulse control valve is "ON".  Air is trapped in system.  Jetter nozzle thrusters are blocked.	Close green pulse control valve to "OFF" position.  Cycle pulse control valves "ON" and "OFF" several times while jetter is running. If problem persists, remove nozzle from jet hose and run jetter to flush air/debris from system.  Remove nozzle and clean thruster orifices with nozzle cleaning tool.
Jetter trips circuit breaker and/or motor overheats/shuts down.	Jetter pressure set too high so that motor amp draw exceeds rating.	Switch jetter "OFF". Reset circuit breaker and/or allow motor to cool for 15-30 minutes. Turn the unloading valve adjustment knob counter-clockwise to reduce pressure. Put both pulse control valves in "OFF" position and restart jetter adjusting pressure to maximum 1250 PSI.
Jetter pressure gage oscillates from 0 to 1250 PSI.	Jetter nozzle thrusters are blocked.  Debris or air trapped in system.	Remove nozzle. Use nozzle cleaning tool to clear nozzle orifices: select proper wire size and push completely through each thruster orifice to remove debris.  Remove nozzle and insert jet hose in drain line. Run jetter and cycle pulse valves to flush trapped air or debris.

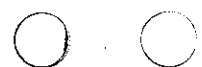



## **RIDGID Lifetime Warranty**

The RIDGID REPUTATION is the result of consistent product quality and years of pride in workmanship. Rigorous checks and controls from raw materials to packaged products insure product confidence widely accepted as the mark of the professional trades. Therefore, RIDGID covers its products with a LIFETIME WARRANTY against defects in material or workmanship. Pipe or drain cleaning tools, rods and cable, are not covered by this warranty and are considered expendable material. To take advantage of this warranty, the complete product must be delivered prepaid to RIDGE TOOL COMPANY or any RIDGID AUTHORIZED SERVICE CENTER. Pipe wrenches and other hand tools should be returned to place of purchase. Obviously, failures due to misuse, abuse, or normal wear and tear are not covered by this warranty. NO OTHER WARRANTY, WRITTEN OR ORAL, APPLIES. No employee, agent, dealer, or other person is authorized to give any warranty on behalf of Ridge Tool Company. Warranted products will be repaired or replaced, at our option, at no charge to you and returned to you via pre-paid transportation. Such replacement or repair is the exclusive remedy available from Ridge. Ridge is not liable for damage of any sort, including incidental and consequential damages. Some U.S.A. states do not allow the exclusion or limitation of incidental or consequential damages, so the above limitation or exclusion may not apply. This warranty gives you specific legal rights, and you may have other rights which vary from state to state.

**Ridge Tool Company**  
400 Clark Street  
Elyria, Ohio 44036-2023



Form No. KJ1250-WJ-1091  
278-086-311