

RIDGID

DIAGNOSTICS & DRAIN CLEANING

PRODUCT CATALOG



BUILT FOR THOSE WHO **KNOW**TM

When you work in the skilled trades, you leave your mark on every job you touch. Your reputation is built over time. Day by day, job by job.

When it's your name on the line, make sure our name is on your tool. For nearly 100 years, we've built our legacy the same way you have – one job at a time. We make tools that stand up to the toughest challenges and last long enough for you to pass them down to the next generation. We deliver a better way to work.

It's more than our promise. We guarantee it.



TABLE OF CONTENTS



8

HAND TOOLS



14

SINK MACHINES



18

DRUM MACHINES



24

SECTIONAL MACHINES



34

FLEXSHAFT™ MACHINES



36

WATER JETTERS



42

REELS AND CAMERAS



54

MONITORS AND RECORDERS



60

HAND-HELD INSPECTION CAMERAS



64

UTILITY LOCATING



74

TEST AND MEASUREMENT

RIDGID® GIVES YOU THE COMPETITIVE EDGE.



THE MOST INNOVATIVE SYSTEM IN THE INDUSTRY.

When problems are lurking in-pipe, behind walls or anywhere underground, more professionals choose RIDGID drain cleaning, diagnostics, inspection and locating tools than any other brand. That's because RIDGID sets the industry standard for ease of use, durability and advanced functionality. Every tool is purpose-built based on feedback from professionals in the field and backed by one of the best warranties in the industry. Build your business with the most complete system of professional drain cleaning, inspection and diagnostic tools available.

SEE IT. FIND IT. SOLVE IT.





BEVELLER
AUGUST 6, 2014

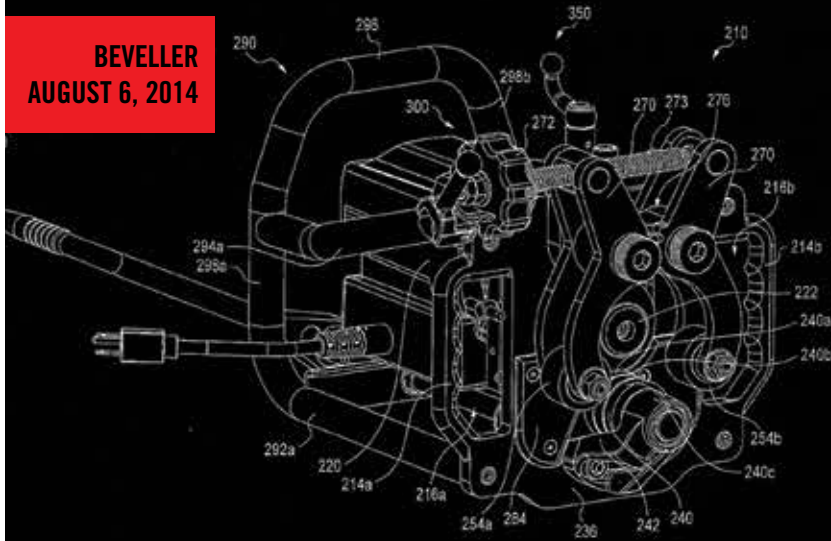

TUBING CUTTER
JULY 24, 1959

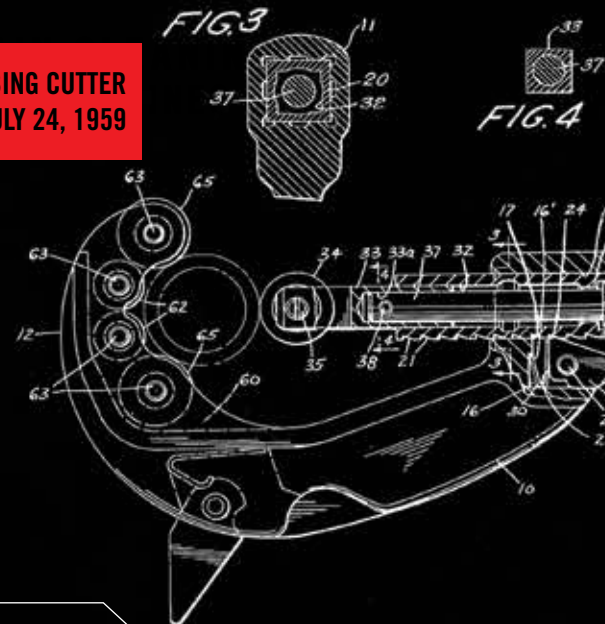

THE BEST NEVER REST.

With more than 100 patents already secured and more on the way, RIDGID® continues to deliver a better way to work. Every diagnostic and drain cleaning product is purpose-built based on feedback from the field. This history of field-driven innovation – coupled with the industry’s best lifetime warranty - makes RIDGID the most trusted brand for trade professionals all around the world.

PIPE WRENCH
MAY 26, 1922

RIDGID.
FULL LIFETIME WARRANTY
Against Material Defects & Workmanship

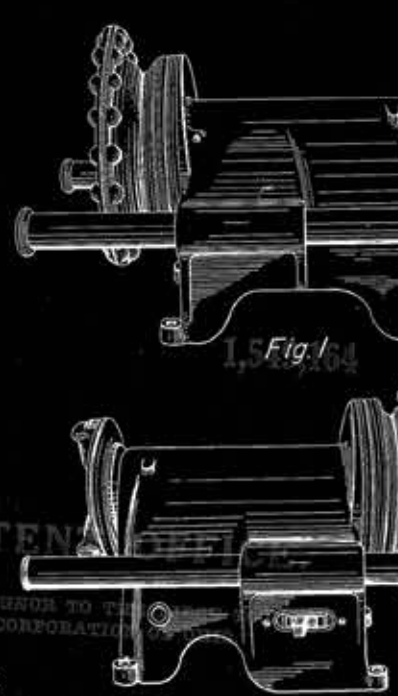
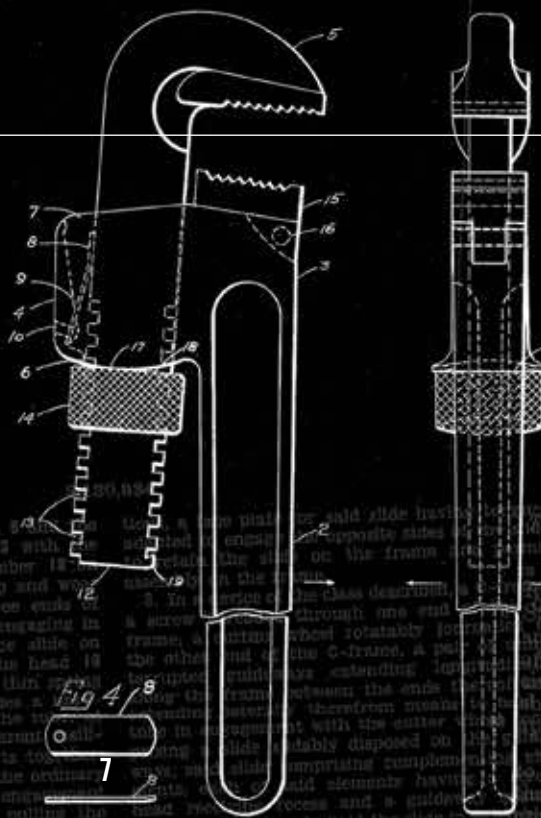

POWER DRIVE
SEPTEMBER 30, 1958

HAND TOOLS



EASILY CLEAR OBSTRUCTIONS IN TOILETS AND DRAIN LINES

RIDGID® hand tools use durable, kink-resistant cables to clear toilet and urinal blockages as well as sink and shower obstructions in lines ranging from 25 to 40 mm. Ergonomically designed, these tools are fast, effective and easy to use.

KEY FEATURES

- | DURABLE, KINK-RESISTANT CABLES
- | ERGONOMIC DESIGN
- | NEGOTIATE WATER-CONSERVING TOILETS



Drill not included

K-1 COMBINATION AUGER

THE URINAL AND SHOWER DRAIN SOLUTION

The K-1 Combination Auger is the all-in-one solution for pipe sizes up to 2" (50 mm). Its dual power operation adds force while its telescoping design helps you reach obstructions further down the line. The "C" cutter head breaks up hard blockages and a left-hand wound cable helps prevent kinking.

- ▶ **PIPE SIZE**
Up to 2" (50 mm)
- ▶ **CABLE LENGTH AND DIAMETER**
4' (1.2 m) cable length, 3/8" (10 mm) cable diameter
- ▶ **OPERATION**
Manual or Drill Powered (*Drill not included*)

CATALOG NO.	MODEL NO.	DESCRIPTION
46683	K-1	4' (1.2 m) Combination Auger



K-3 TOILET AUGER

FAST AND SAFE CLEARING FOR MOST TOILETS

The K-3 toilet auger features large, ergonomically designed handles for greater control. It can navigate water-conserving toilets while the vinyl guard protects the porcelain.

- ▶ **CABLE LENGTH**
Available in 3' (1 m) with bulb head
- ▶ **CABLE SIZE**
1/2" (12 mm) compression-wrapped Inner Core Cable
- ▶ **KEY FEATURES**
Vinyl guard protects porcelain
Large, ergonomically designed handles
Perfect for water-conserving toilets

CATALOG NO.	MODEL NO.	DESCRIPTION
59787	K-3	3' (1 m) Toilet Auger with Bulb Head



Drill not included



K-6P TOILET AUGER

DUAL POWERED OPERATION FOR TOUGH TOILET CLOGS

The new K-6P toilet auger uses heavy-duty Tri-Wrap cable to power through the toughest blockages. The optional drill attachment lets you increase the torque to 500 RPM while the quick lock adjustment extends the cable 6' (1.83 m) beyond the toilet. Zinc-plated steel tubing helps resist corrosion and preserve your tool.

► **OPTIONAL DRILL ATTACHMENT**

Power through serious blockages with 500 RPM maximum (*Drill not included*)

► **QUICK LOCK ADJUSTMENT**

Extends the cable 6' (1.83 m) to clear beyond the toilet

► **CORROSION RESISTANT**

Zinc-plated steel tubing

► **MAXIMUM STRENGTH**

Heavy-duty Tri-Wrap cable, ½" (12 mm)

CATALOG NO.	MODEL NO.	DESCRIPTION
56658	K-6P	6' (1.83 m) Toilet Auger with Bulb Head





K-25 HAND SPINNER

CLEARs ¾" TO 1½" (20 TO 40 MM) DRAIN LINES

The RIDGID® K-25 has been a favorite with professionals for decades. Its precision-machined, 3-jaw chuck keeps the cable secure while a simple flick of the wrist releases the cable. With a sturdy cast aluminum ribbed hand grip and a rotary molded plastic drum that won't dent or rust, this spinner works through traps and bends in: sinks, tubs, drinking fountains, lavatories, urinals and vent pipes.

► **MULTIPLE HEADS**

Bulb head and drop head models available

► **KINK-RESISTANT CABLES**

25' of vinyl-wrapped inner core 5/16" cable (8 mm x 7.6 m)

► **DRUM CAPACITY**

5/16" x 25' (8 mm x 7.6 m)

► **PROFESSIONAL GRADE**

Precision machined, 3-jaw chuck with flick-of-the-wrist release

Cast aluminum ribbed hand grip reduces slippage

Rotary molded plastic drum won't dent or rust

CATALOG NO.	MODEL NO.	DESCRIPTION
58890	K-25-BP	Hand Spinner w/C-1IC Bulb Auger Cable
58895	K-25-DH	Hand Spinner w/C-2IC Drop Head Cable



K-26 HAND SPINNER

CLEARs ¾" TO 1½" (20 TO 40 MM) DRAIN LINES

The RIDGID K-26 hand spinner delivers outstanding performance and value. A slip-resistant collet chuck firmly grips the cable with a flick of the wrist. The rotary molded plastic drum cleans easily while resisting rust and dents.

► **CABLE SIZE**

5/16" x 25' (8 mm x 7.6 m) hollow core cable with bulb head auger

► **KEY FEATURES**

Slip-resistant collet chuck grips with a flick of the wrist

Rotary molded plastic drum cleans easily

► **OPEN DRUM DESIGN**

Provides access to cable to allow for application of RIDGID Cable Rust Inhibitor

CATALOG NO.	MODEL NO.	DESCRIPTION
59812	K-26	Hand Spinner w/C1 Bulb Head Cable



KWIK-SPIN+™ HAND SPINNER WITH AUTOFEED®

CLEARs ¾" TO 1½" (20 TO 40 MM) DRAIN LINES

With AUTOFEED Trigger Technology, just pull the trigger and let the cable self-feed down the drain. 25' of ¼" (7.6 m x 6 mm) MAXCORE cable is positively retained in the drum to prevent cable pullout. The lightweight polyethylene drum stands up to dents or rust.

▶ **AUTOFEED TRIGGER TECHNOLOGY**

Pull the trigger and turn the drum for a clean drain without the hassle

▶ **CABLE SIZE**

25' of ¼" MAXCORE cable (7.6 m x 6 mm)

▶ **CONTAINED CLEAN**

Cable is positively retained in the drum to prevent cable pullout

Lightweight polyethylene drum will not dent or rust

CATALOG NO.	MODEL NO.	DESCRIPTION
57038	Kwik-Spin+	Hand Spinner w/AUTOFEED





POWER SPIN+™ WITH AUTOFEED®

CLEAR 3/4" TO 1 1/2" (20 TO 40 MM) DRAIN LINES

AUTOFEED Trigger Technology self-feeds 25' of 1/4" (7.6 m x 6 mm) kink-resistant MAXCORE cable down the drain. For tough clogs, switch to drill powered operation for up to 500 RPM of clearing power. Power Spin+ with AUTOFEED is great for use in tubs, sinks and showers.

- ▶ **AUTOFEED TRIGGER TECHNOLOGY**
Pull the trigger and turn the drum for a clean drain without the hassle
- ▶ **ADDITIONAL POWER**
Switch to drill-powered operation for up to 500 RPM cable speed (*Drill not included*)
- ▶ **CABLE SIZE**
25' of 1/4" kink-resistant MAXCORE cable (7.6 m x 6 mm)
- ▶ **CLEAN DRAIN. CLEAN HANDS.**
Cable is positively retained in the drum to prevent cable pullout
Lightweight polyethylene drum will not dent or rust

CATALOG NO.	MODEL NO.	DESCRIPTION
57043	Power Spin+	Power Spinner Drain Cleaner



Drill not included



SINK MACHINES

BIG POWER FOR SMALL LINE BLOCKAGES

RIDGID® Sink Machines are the professional's choice for clearing small line blockages in lavatories, sinks, tubs and showers. With a variety of cable sizes and cutter options, RIDGID sink machines can clear lines ranging from 20 to 75 mm. Lightweight and easily transported, these professional-grade drain cleaners excel in hard-to-reach spaces.

KEY FEATURES

- | **SMALL LINE CLEARING**
- | **PATENTED AUTOFEED® TECHNOLOGY**
- | **PERFECT FOR TIGHT SPACES**

POWERCLEAR™ MACHINE

CLEAR 3/4" TO 1 1/2" (20 TO 40 MM) DRAIN LINES

Powerful, compact and simple to use. The RIDGID® PowerClear machine breaks through tub, shower or sink blockages with ease. AUTOFEED® Technology lets you advance and retrieve the cable without getting your hands dirty. And, the heavy-duty inner core cable is purpose-built for a long life free from kinks.

- ▶ **AUTOFEED TECHNOLOGY**
Advance and retrieve without handling the cable
- ▶ **CLEAR COVER**
Lets you see how much cable remains
- ▶ **HEAVY-DUTY INNER CORE CABLE**
Long-lasting and kink resistant
- ▶ **TWO-PIECE GUIDE HOSE**
One piece for close applications; an extension when access is limited
- ▶ **EASY PULL DRAIN PLUG**
Drain excess water after each use to extend cable life

CATALOG NO.	MODEL NO.	DESCRIPTION
59143	PowerClear	Drain Cleaning Machine, 230 V
60753	PowerClear	Drain Cleaning Machine, 230 V (UK-plug)



DRAIN CLEANING SINK MACHINES



K-40 SINK MACHINE

CLEARs ¾" TO 2 ½" (20 TO 75 MM) DRAIN LINES

More torque – less mess. That's the RIDGID® K-40 Sink Machine. A 175-watt induction motor quietly delivers enough force to blast through the toughest blockages, and the two-piece "twist lock" drum housing with its special inner drum design virtually eliminates cable flip-over inside the drum.

▶ **PORTABLE POWER**

Machine sits flat on the floor or countertop or tips onto its back for greater access in tight spaces

▶ **AUTOFEED® TECHNOLOGY**

Advance and retrieve without handling the cable

▶ **TWIST LOCK DRUM**

Special inner drum virtually eliminates cable flip

▶ **QUIET POWER**

175-watt induction motor quietly delivers the torque needed for the toughest blockages

▶ **COMPRESSION-WOUND CABLE**

Added strength with the flexibility to prevent kinking

CATALOG NO.	MODEL NO.	DESCRIPTION
71717	K-40AF	110 V Machine with: AUTOFEED, Guide Hose, Mounting Bracket, C-131C SB, 5/16" x 35' (8 mm x 10.7 m) Speed Bump Cable with Inner Drum
71742	K-40AF	230 V Machine with: AUTOFEED, Guide Hose, Mounting Bracket, C-131C SB, 5/16" x 35' (8 mm x 10.7 m) Speed Bump Cable with Inner Drum





K-45 SINK MACHINE

CLEARs ¼" TO 2½" (20 TO 75 MM) DRAIN LINES

The RIDGID® K-45 Sink Machine effectively opens clogged lavatory, sink lines, urinals, tubs and shower drains. Available in two styles – Manual and AUTOFEED® – the K-45 is lightweight, easy to use and packs a punch. Its variable speed power unit rotates cable 0 – 600 RPM.

- ▶ **AUTOFEED TECHNOLOGY**
Advance and retrieve without handling the cable
- ▶ **VARIABLE SPEED POWER**
Rotate cable 0 to 600 RPM
- ▶ **TWO-PIECE TWIST LOCK DRUM**
Special inner drum virtually eliminates cable flip and makes cable changeout simple
- ▶ **MULTIPLE CABLE OPTIONS**
 - ¼" (6 mm) cables for 20 to 40 mm lines
 - ⅝" (8 mm) cables for 20 to 40 mm lines
 - ⅞" (10 mm) cables for 40 to 75 mm lines



CATALOG NO.	MODEL NO.	DESCRIPTION
36033	K-45AF	230 V Machine with: AUTOFEED, C-11C, ⅝" x 25' (8 mm x 7.6 m) Inner Core Cable with Inner Drum
63703	K-45AF	230 V (UK) Machine with: AUTOFEED, C-11C, ⅝" x 25' (8 mm x 7.6 m) Inner Core Cable with Inner Drum, with UK Power Plug
37338	K-45AF	110 V Machine with: AUTOFEED, C-11C, ⅝" (8 mm) x 25' (7.6 m) Inner Core Cable with Inner Drum, with UK Power Plug
36043	K-45AF-5	230 V Machine with: AUTOFEED, C-11C, ⅝" x 25' (8 mm x 7.6 m) Inner Core Cable with Inner Drum, C-6, ⅞" (10 mm) x 25' (10.7 m) Cable with Inner Drum, T-250 Five-Piece Tool Set for ⅞" (10 mm) Cable, C-6429 Carrying Case
63698	K-45AF-5	230 V (UK) Machine with: AUTOFEED, C-11C, ⅝" x 25' (8 mm x 7.6 m) Inner Core Cable with Inner Drum, C-6, ⅞" (10 mm) x 25' (10.7 m) Cable with Inner Drum, T-250 Five-Piece Tool Set for ⅞" (10 mm) Cable, C-6429 Carrying Case, with UK Power Plug
37343	K-45AF-5	110 V Machine with: AUTOFEED, C-11C, ⅝" (8 mm) x 25' (7.6 m) Inner Core Cable with Inner Drum, C-6, ⅞" (10 mm) x 25' (10.7 m) Cable w/Inner Drum, T-250, Five-Piece Tool Set for ⅞" (10 mm) Cable, C-6429 Carrying Case, with UK Power Plug



DRUM MACHINES

TOUGH ON BLOCKAGES. EASY ON YOU.

RIDGID® drum machines combine high torque, long-running motors with durable cables and cutters to clear blockages in lines ranging from 20 to 250 mm. Containing the cable within the drum maximizes cable life while keeping jobsites cleaner.

KEY FEATURES

- | HIGH TORQUE
- | SUPERIOR MOBILITY
- | PATENTED CABLE CONTROL SYSTEM

DRAIN CLEANING DRUM MACHINES



K-400



K-3800



K-750



K-7500

APPLICATION CHART

	SINK LINES		LATERALS & MAIN LINES	
	FLOOR/SECONDARY DRAINS			
LINE SIZE:	40 - 100 mm	20 - 100 mm	75 - 200 mm	75 - 250 mm
SPEED:	170 RPM	240 RPM	200 RPM	200 RPM
MOTOR TYPE HORSEPOWER:	Induction 380 W	Universal 175 W	Induction 550 W	Universal 600 W
WEIGHT*:	20.4 kg	19 kg	47.3 kg	86.2 kg

*Machine only without Cable

CABLES FOR DRUM MACHINES

PRODUCTS:	K-400		K-750 & K-7500	
	K-3800			
CABLE DIAMETER:	3/8" (10 mm) Cable	1/2" (12 mm) Cable	5/8" (16 mm) Cable	3/4" (20 mm) Cable
AVAILABLE LENGTHS:	15 m - 23 m - 30 m	15 m - 23 m - 28 m	7.6 m - 15 m - 23 m - 30 m	7.6 m - 15 m - 23 m - 30 m
CABLE TYPE*:	Integral Wound (IW), Inner Core (IC)	Inner Core (IC), Integral Wound (IW), Hollow Core (HC)	Heavy-Duty Inner Core (HD), Inner Core (IC), Hollow Core (HC)	Heavy-Duty Inner Core (HD), Inner Core (IC), Hollow Core (HC)

*Each machine has its specific cable compatibility

Inner Core Cables Compression-wound for strength, it also resists kinking and negotiates tough bends and traps. Good flexibility while delivering more cleaning power to cable end.

Integral Wound Core Cables Cable is wound tight on wire inner core, creating a solid assembly. Has greater kink resistance.

Hollow Core Cables Provide maximum flexibility for severe bends and traps.

Heavy-Duty Cables Cable is wound tight on wire inner core for excellent stiffness under load.

DRAIN CLEANING DRUM MACHINES

K-400 DRUM MACHINE

CLEARs 1½" TO 4" (40 TO 100 MM) DRAIN LINES

The sleek design and user-friendly features make the K-400 an ideal drum machine for drain cleaners, service plumbers, facility and institutional maintenance departments and property management companies.

- ▶ **INTEGRATED TRANSPORT CART**
Heavy-duty wheels traverse uneven ground or stairs
- ▶ **INTEGRATED TELESCOPING HANDLE**
High-handle height during transport locks into a lower position during operation
- ▶ **PATENTED CABLE CONTROL SYSTEM**
Drum stops spinning when the blade lodges in a blockage to mitigate cable flip in the drum
- ▶ **"SOLID CORE" CABLE**
Rugged and kink-resistant ¾" (10 mm) or ½" (12 mm) Integral Wound (IW) solid core cable
- ▶ **AUTOFEED®**
Patented, automatic cable feed powers cable in and out of the drain (available as an accessory)
- ▶ **CABLE OPTIONS**
23 m of ¾" (10 mm) cable for 40 to 75 mm lines (C-32 IW)
23 m of ½" (12 mm) cable for 75 to 100 mm lines (C-45 IW)



CATALOG NO.	MODEL NO.	DESCRIPTION
27028	K-400 w/C-32 IW	230 V Machine w/Gloves & Std. Equipment: C-32 IW ¾" x 75' (10 mm x 23 m) Solid Core (Integral Wound) Cable and T-260 Tool Set
27033	K-400 w/C-45 IW	230 V Machine with Gloves & Std. Equipment: C-45 IW ½" x 75' (12 mm x 23 m) Solid Core (Integral Wound) Cable and T-260 Tool Set
28098	K-400 AF w/C-32 IW	230 V Machine with Gloves & Std. Equipment: AUTOFEED, C-32 IW ¾" x 75' (10 mm x 23 m) Solid Core (Integral Wound) Cable and T-260 Tool Set
28103	K-400 AF w/C-45 IW	230 V Machine with Gloves & Std. Equipment: AUTOFEED, C-45 IW ½" x 75' (12 mm x 23 m) Solid Core (Integral Wound) Cable and T-260 Tool Set

K-3800 DRUM MACHINE

CLEARs 3/4" TO 4" (20 TO 100 MM) DRAIN LINES

Powerful, easy-to-transport and versatile, the K-3800 is great for clearing indoor drains, sink lines, floor drains and roof vents. The rugged, corrosion-resistant drum won't dent or rust while an inner drum protects against cable flip-over inside the drum.

▶ **UNIVERSAL MOTOR**

175 W, 240 RPM universal motor automatically gears down for more power when cable hits blockage

▶ **PORTABILITY**

Cable drum's quick release and built-in hand-holds for easy cable change and transport

▶ **CAPACITY**

Standard drum capacity is 30 m of 3/8" (10 mm) or 28 m of 1/2" (12 mm) continuous length cable

▶ **CABLE SIZE**

3/8" (10 mm) cable is best for 40 to 75 mm lines up to 30 m

1/2" (12 mm) IC cable is best for 50 to 100 mm lines up to 28 m

▶ **SINK OPTIONS**

Optional sink drum holds up to 15 m of 5/16" (8 mm) or 1/4" (6 mm) cable – ideal for cleaning 20 to 40 mm sink traps

▶ **CABLE STRENGTH**

Integral Wound (IW) cables – which are slightly stiffer and more kink resistant – are available



CATALOG NO.	MODEL NO.	DESCRIPTION
61502	K-3800	230 V Machine with Gloves
61482	K-3800 w/C-32	230 V Machine with: C-32, 3/8" x 75' (10 mm x 23 m) Cable, T-202 Bulb Auger, T-205 "C" Cutter, T-211 Spade Cutter and A-13 Pin Key
61487	K-3800 w/C-45	230 V Machine with: C-45, 1/2" x 75' (12 mm x 23 m) Cable, T-102 Funnel Auger, T-142 Knife Blade Cutter, T-107 Spade Cutter and A-12 Pin Key

K-750 DRUM MACHINE

CLEARs 3" TO 8" (75 TO 200 MM) DRAIN AND SEWER LINES

The RIDGID® K-750 is a powerful, self-contained drum machine that's ideal for clearing lateral lines. Balanced design gives the machine a lightweight feel while transport wheels make loading on and off the truck easier.

► **RECOMMENDED CABLES**

5/8" (16 mm) cable for 75 to 150 mm drain lines up to 46 m

3/4" (20 mm) cable for 100 to 200 mm drain lines up to 61 m

► **VERSATILE AUTOFEED®**

Advance and retrieve cable up to 20' (6 m) per minute

Adjust for either 5/8" (16 mm) or 3/4" (20 mm) cable with a twist of a screwdriver

► **SERIOUS STORAGE**

Drum holds 100' (30 m) of 3/4" (20 mm) or 125' (38 m) of 5/8" (16 mm) cable and is designed for quick, easy removal



CATALOG NO.	MODEL NO.	DESCRIPTION
44147	K-750	230 V Machine with Gloves and AUTOFEED - 3/4" (20 mm) Pigtail
44152	K-750 with C-75	230 V Machine with One Pair of Gloves, AUTOFEED, Standard 3/4" (20 mm) Tool Set, and: C-75, 75' (23 mm) x 3/4" (20 mm) Cable
44157	K-750 with C-100	230 V Machine with One Pair of Gloves, AUTOFEED, Standard 3/4" (20 mm) Tool Set, and: C-100, 100' (30.5 mm) x 3/4" (20 mm) Cable
44162	K-750 with C-27	230 V Machine with One Pair of Gloves, AUTOFEED, Standard 5/8" (16 mm) Tool Set, and: C-27, 75' (23 mm) x 5/8" (16 mm) Cable



K-7500 DRUM MACHINE

CLEAR 3" TO 10" (75 TO 250 MM) DRAIN LINES

The RIDGID K-7500 Drum Machine is the definition of heavy-duty. Its powerful – yet surprisingly quiet – 600 Watt universal motor spins cables at 200 RPM making it an ideal solution for tough obstructions like roots. Narrow enough to fit through bathroom doors, the K-7500 also features a two-position stair climber and adjustable handles for ease of transport and loading.

- ▶ **CABLE CONTROL**
Inner-drum and ball bearing distributor arm work in tandem with motor and gearbox system to reduce cable flip inside the drum
- ▶ **AUTOFEED**
Grease fittings and an open design make for easy maintenance
AUTOFEED advances and retrieves cable up to 22' (6.7 m) per minute
- ▶ **TRANSPORT ASSIST**
Two-position stair climber eliminates extra cost for loading wheels



CATALOG NO.	MODEL NO.	DESCRIPTION
61522	K-7500	230 V Machine with 5/8" (16 mm) Pigtail and Standard Accessories
61512	K-7500 with C-24	230 V Machine, Standard Accessories, and 5/8" x 100' (16 mm x 30 m) Inner Core Cable
61542	K-7500	230 V Machine with 3/4" (20 mm) Pigtail and Standard Accessories
61517	K-7500 with C-100	230 V Machine, Standard Accessories, and 3/4" x 100' (20 mm x 30 m) Inner Core Cable.





SECTIONAL MACHINES

PORTABLE POWER. TOTAL CONTROL.

All RIDGID® Sectional Machines come equipped with a unique, instant-acting cable clutch for maximum operator control. Push the handle down and the cable spins. Release the handle and the cable stops instantly.

KEY FEATURES

- | INSTANT-ACTING CABLE CLUTCH
- | HIGH-SPEED CUTTING ACTION
- | HIGHLY PORTABLE

DRAIN CLEANING SECTIONAL MACHINES



K-50



K-60SP



K-5208



K-1500SP-A

APPLICATION CHART

	SINK LINES		LATERALS & MAIN LINES	
	FLOOR/SECONDARY DRAINS			
LINE SIZE:	20 - 100 mm	32 - 150 mm	50 - 200 mm	50 - 250 mm
SPEED:	400 RPM	600 RPM	585 RPM	600 RPM
MOTOR TYPE HORSEPOWER:	300 W	700 W	1248 W	1500 W
WEIGHT:	16.8 kg	19.5 kg	25 kg	60 kg

CABLES FOR SECTIONAL MACHINES

PRODUCTS:	K-50		K-60SP		K-5208, K-1500SP & K-1500G	
CABLE DIAMETER:	5/8" (16 mm)	5/8", 7/8" (16 mm, 22 mm)	7/8", 1 1/4" (22 mm, 32 mm)			
AVAILABLE LENGTHS:	2.3 m - 3.1 m	2.3 m - 3.1 m - 4.6 m	4.6 m			
CABLE TYPE:	Tight Wound, All-Purpose Wound, Heavy-Duty Wound	Tight Wound, All-Purpose Wound, Heavy-Duty Wound, Plastic Core	All-Purpose Wound, Plastic Core, Extra Heavy-Duty Wound, Heavy-Duty Wound, Extra Flexibility			

Tight Wound Cable provides good rigidity in a hollow core cable.

All Purpose Wound Provides excellent flexibility, yet rigid enough for fast tough cleaning.

Heavy-Duty Wound Open wind especially good for long runs.

Extra Heavy-Duty Wound Designed for 4' to 10' long runs.

Plastic Core Standard all-purpose wind with plastic core to help prevent buildup inside cable.

Extra Flexibility Recommended for 3" to 6" lines and ideal for 4" traps.

DRAIN CLEANING SECTIONAL MACHINES

K-50 SECTIONAL MACHINE

CLEARs 3/4" TO 4" (20 TO 100 MM) DRAIN LINES

Compact and versatile, the K-50 has the capability to run three different cable sizes: 5/16" (8 mm), 3/8" (10 mm) and 5/8" (16 mm). At under 18 kg, it's a great all-around sink, shower and floor drain machine.

► RECOMMENDED USAGE

C-8 is best for 32 to 75 mm drains (2.3m x 16mm)

C-9 is best for 50 to 100 mm drains (3.1 m x 16 mm)

A-17-A Adapter is best for 20 to 40 mm drains (7.6m x 8 mm)

A-17-B Adapter is best for 40 to 50 mm drains (10.7m x 10 mm)

► INSTANT-ACTING CABLE CLUTCH

Maximizes operator control

Pull handle down and cable spins. Release handle and cable stops instantly

► POWERFUL MOTOR

300 Watt motor spins cable at 400 RPM

CATALOG NO.	MODEL NO.	DESCRIPTION
11971	K-50	230 V Machine Only
11981	K-50-6	230 V Machine with A-17-A Adapter, A-30 Cable Kit
11991	K-50-7	230 V Machine with A-17-B Adapter, A-30 Cable Kit
12001	K-50-8	230 V Machine with A-17-A Adapter, A-17-B Adapter, A-30 Cable Kit





K-60SP SECTIONAL MACHINE

CLEAR 1¼" TO 6" (32 TO 150 MM) DRAIN LINES

The 700 Watt motor on the RIDGID® K-60SP Section Machine is ideal for institutional, commercial or residential jobs. Its rear handle makes it easier to carry up ladders to clear rooftop vent stacks and it's quickly become a favorite of septic tank vacuum truck operators.

► **RECOMMENDED USAGE**

7/8" (22 mm) cable (C-10) cleans 50 to 100 mm lines through 46 m

5/8" (16 mm) cable (C-7, C-8, C-9) cleans 32 to 100 mm lines through 38 m

► **INSTANT-ACTING CABLE CLUTCH**

Maximizes operator control

Pull handle down and cable spins. Release handle and cable stops instantly

► **POWERFUL MOTOR**

700 W motor

► **EASY ACCESS**

Remove two bolts to access jaw set for cleaning or replacement as well as access to belt drive

► **ADJUST IN SECONDS**

Simple adjustment knob allows unit to spin both 7/8" (22 mm) and 5/8" (16 mm) diameter cable



CATALOG NO.	MODEL NO.	DESCRIPTION
66467	K-60SP	230 V Machine with A-1 Operator's Mitt, A-12 Pin Key, and A-60-12 Rear Guide Hose
66472	K-60SP-SE	230 V Machine with A-1 Operator's Mitt, A-12 Pin Key, and A-60-12 Rear, Guide Hose, plus: A-61 Tool Kit and A-62 Cable Kit

DRAIN CLEANING
SECTIONAL MACHINES

EVERY DETAIL WITH PURPOSE

RIDGID.EU/K5208



IN-FIELD SERVICEABILITY
Minimize downtime

**TOOL-LESS CLUTCH
ADJUSTMENT**
Quickly switch
cable sizes

SQUARE TUBING
Added strength
and durability

DRAIN PLUG
For increased
bearing life

**TRIDENT
DECOUPLING TOOL**
Easily disconnect
cable sections

RUBBER FEET
Anti-slip grip

SECTIONAL CABLE CARRIER
Easy load and unload Cable sections

K-5208 SECTIONAL MACHINE

CLEARs 2" TO 8" (50 TO 200 MM) DRAIN LINES

The RIDGID® K-5208 is the most powerful, compact sectional machine on the market. Power meets portability as this machine is 35% lighter and 71% smaller than previous RIDGID sectional drain cleaners. It's the sectional machine you need on your van.



- ▶ **MORE POWER**
1248 W motor spins cable at 700 RPM
- ▶ **TOOL-LESS CLUTCH ADJUSTMENT**
Quickly switch between cable sizes without additional tools
- ▶ **IN-FIELD SERVICEABILITY**
Minimize downtime when maintenance is necessary
- ▶ **FLUID MANAGEMENT SYSTEM**
Delivers a cleaner work environment
- ▶ **TRIDENT DECOUPLING TOOL**
Easily disconnects cable sections
- ▶ **SECTIONAL CABLE CARRIER**
Allows easier cable loading and unloading of the machine
- ▶ **BONUS UPGRADES**
Quick-dump cord management for faster setup
Square steel tubing for enhanced strength and durability



CATALOG NO.	MODEL NO.	DESCRIPTION
61698	K-5208	230 V Machine Includes: Trident Sectional Cable Decoupler, Rear Guide Hose, RIDGID Drain Cleaning Mitt (LH)
64423	K-5208 with C-10	230 V Machine Includes: Trident Sectional Cable Decoupler, (1) Cable Carrier Assembly, (5) C-10 Cables, 7-Piece Toolbox (A-61), Rear Guide Hose, RIDGID Drain Cleaning Mitt (LH)
61703	K-5208 with C-11	230 V Machine includes: Trident Sectional Cable Decoupler, (1) Cable Carrier Assembly, (4) C-11 Cables, 7-Piece Toolbox, Rear Guide Hose, RIDGID Drain Cleaning Mitt (LH)

**110 V Machine & Kit configurations are available.*



Transport Cart carries both Machine and Cable Carrier
Cat. #64863



Cable Carrier
Cat. #61708
(Cables not included)



Trident Sectional Cable Decoupler
Cat. #61718

K-5208 Kit
Cat. #61703



K-1500SP SECTIONAL MACHINE

CLEAR 2" TO 10" (50 TO 250 MM) DRAIN AND SEWER LINES

One man can easily clear the heaviest blockages – indoors or out – with the heavy-duty K-1500SP sectional machine. It's unique, instant-acting cable clutch maximizes operator control of a 1500-watt motor. Pull the handle down and the cable spins at 600 RPM. Release the handle and the cable stops instantly. The K-1500SP has a low-profile design with 10" solid ball bearing wheels that makes getting in and out of the job easier.

- ▶ **HEAVY-DUTY POWER**
1500 W motor spins cable at 600 RPM
- ▶ **EASY CLUTCH JAW CHANGE-OUT**
Adapts to run 15' (4.6 m) sections of 7/8" (22 mm) cable through 50 to 100 mm lines up to 53 m
- ▶ **CLEAN 75 TO 250 MM LINES UP TO 91 m**
Using easy-to-handle 15' (4.6 m) sections of 1 1/4" (32 mm) cable

Machine Options – A Frame

CATALOG NO.	MODEL NO.	DESCRIPTION
45302	K-1500SP-A	110 V Machine includes: A-1 Operator's Mitt and A-12 Pin Key, Plus: A-34-12 Rear Guide Hose, with UK Power Plug
45312	K-1500SP-A	230 V Machine includes: A-1 Operator's Mitt and A-12 Pin Key, Plus: A-34-12 Rear Guide Hose
45307	K-1500SP-A SE	110 V includes: A-1 Operator's Mitt and A-12 Pin Key, A-34-12 Rear Guide Hose, A-34-12 Rear Guide Hose, 105' (32 m), Seven Sections of C-11, 1 1/4" (32 mm) Cable, Two A-8 Cable Carriers, A-3 Tool Box, Six-Piece 1 1/4" (32 mm) Tool Package, with UK Power Plug
45317	K-1500SP-A SE	230 V includes: A-1 Operator's Mitt and A-12 Pin Key, A-34-12 Rear Guide Hose, A-34-12 Rear Guide Hose, 105' (32 m), Seven Sections of C-11, 1 1/4" (32 mm) Cable, Two A-8 Cable Carriers, A-3 Tool Box, Six-Piece 1 1/4" (32 mm) Tool Package

IT ALL STARTS WITH SELECTING THE RIGHT CABLE & TOOLS

WHY WE RECOMMEND RIDGID ORIGINAL CABLES AND TOOLS?

1. RIDGID cables and tools are designed to work properly with RIDGID machines.
2. Original cables will fit in your machine.
3. RIDGID cable and machines come with the Lifetime warranty.
4. Using original RIDGID cables and tools with RIDGID machine ensures proper operation of all components.

▶ ALL PURPOSE

Standard all-purpose open wind. Flexible, yet rigid enough to do fast, tough root cutting



▶ HEAVY-DUTY

Heavy-Duty open wind cable ideal for long runs



▶ HOLLOW CORE

Hollow core cables that provide maximum flexibility for severe bends and "P" Traps



▶ INNER CORE

Inner core cables that provide good flexibility while resisting kinking



▶ TIGHT WIND

Tight wind cable providing good rigidity in a hollow core cable. Not for tree roots



▶ OPEN WIND

Open wind acts as an auger to thoroughly remove blockages in lines. excellent Flexibility



Disconnect cables & tools fast and easy with the trident sectional cable decoupler

**RIDGID offers a wide variety of cables. Check the individual Machine specifications, to select the right cable for your machine and for your application.*

DRAIN CLEANING SECTIONAL CABLE TOOLS

RIDGID® offers a wide variety of cutters and augers to clean everything from grease to root blockages. With the RIDGID line of cable tools, you will always have the right tool for the job.

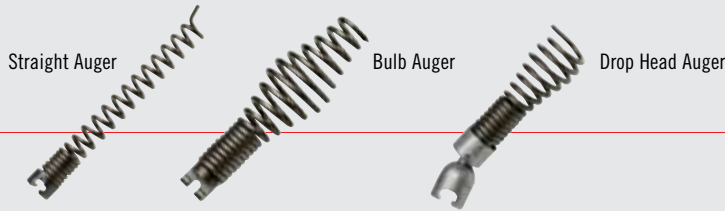

*Tools shown are not to scale or proportional with each other.

Initial / Exploratory



Follow-Up

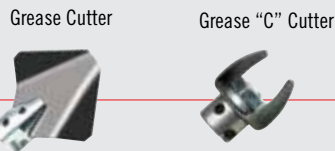

Grease Blockages

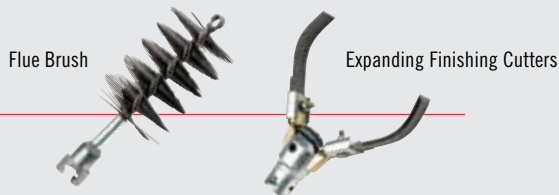

Finishing Tools



Miscellaneous Tools

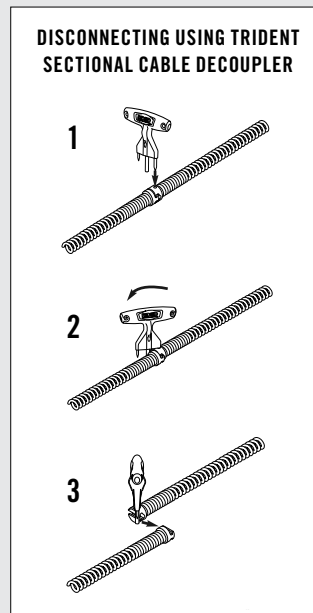

DRAIN CLEANING SECTIONAL CABLE TOOLS

DROP HEAD AUGER

For cleaning back to back mounted fixtures e.g., sinks where cable needs to be led into down pipe.

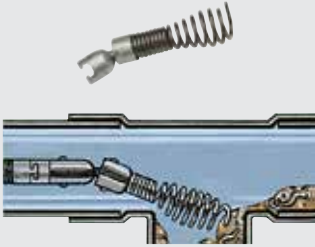

STRAIGHT AUGER

For use in exploring and breaking up stoppages or returning sample to surface to determine correct tool.

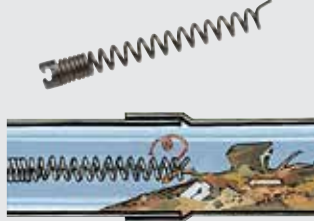

FUNNEL AUGER

For use as second tool in line. Breaks up remains of stoppage left by straight auger.

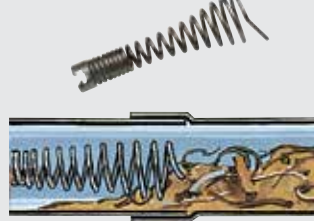

HOOK AUGER

For heavy and dense root stoppages in pipes that require hooking and breaking up.

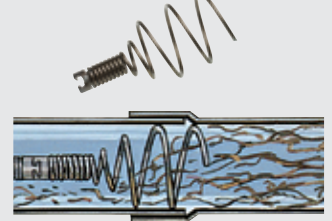

RETRIEVING AUGER

For searching for cable which is broken or lost in line.

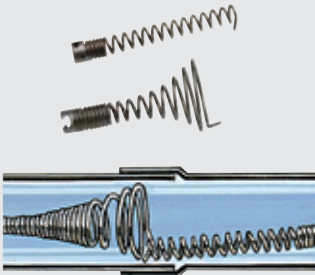

SPADE CUTTER

For following up after augers have been used and to open up floor drains.

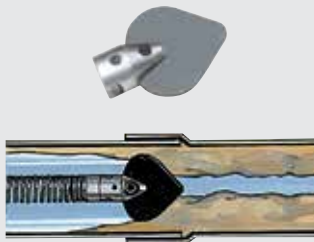

FOUR BLADE SAW TOOTH CUTTER

For blockages caused by hardened, glazed material such as chemical deposits.

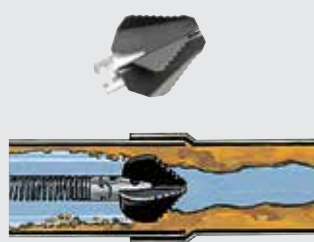

GREASE CUTTER

For lines which have become badly greased with detergents and have to be opened.



SPIRAL SAW TOOTH CUTTER

For clearing any stoppage, roots, rags, sticks, etc.

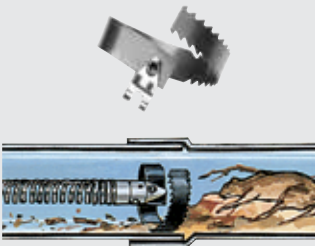

SAW TOOTH CUTTER

For cleaning lines blocked heavily with roots. Unique design permits cutter to be removed from damaged pipe without locking.

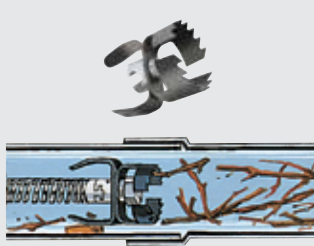

SPIRAL BAR CUTTER

For main sewers blocked by roots, leaf debris, sticks, sawdust, cloth, and sacking.

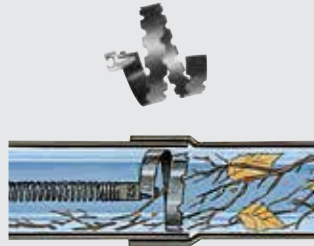

SHARKTOOTH CUTTER

For use in cleaning pipes of general material clinging to pipe walls.

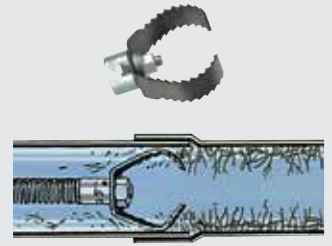

GREASE "C" CUTTER

For grease blockage in lines leading from garbage disposal unit or waste pipe.



EXPANDING FINISH CUTTERS

For final removal of material adhering to walls and certain roots of fibrous nature.

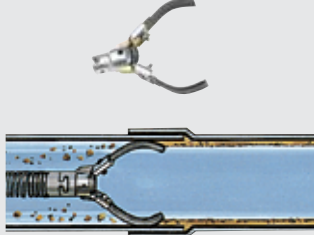

CHAIN KNOCKER

For use when vigorous action is required for cleaning of scale in pipes and boiler tubes.



FLUE BRUSH

For use for finish cleaning required of boiler tubes and heat exchangers.

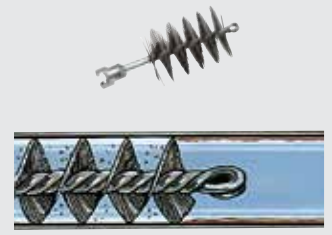

DRAIN CLEANING
FLEXSHAFT™ MACHINES

INTRODUCING RIDGID
FlexShaft™
MACHINES

**FLEX YOUR
COVERAGE**

RIDGID.EU/FLEXSHAFT



Drill not included

RIDGID® FLEXSHAFT MACHINES

CLEAR FROM 1¼" TO 4" (32 TO 100 MM) DRAIN LINES

RIDGID FlexShaft machines are purpose-built for busy drain cleaning professionals. These lightweight, compact and highly efficient machines deliver wall-to-wall clean in 32 to 100 mm drain lines up to 21 m. Specialized chain knockers attached to a flexible cable are spun at high speeds by a cordless drill (equipped with a clutch) attached to the center drive shaft. Since the cable spins inside a durable nylon sheath that is

housed within a fully contained drum, there is less jobsite mess. With a wide variety of chain knockers, lubricants and accessories available, FlexShaft machines can be customized to fit your needs. FlexShaft machines can also be operated while an inspection camera is in the line letting you see while you clean. No other soft blockage expert can do that.

▶ **WALL-TO-WALL CLEAN**

Chain knockers expand for full pipe cleaning

▶ **SIMULTANEOUS CAMERA USE**

FlexShaft machines let you keep your camera in-pipe while you work

▶ **INCREASE PRODUCTIVITY**

Faster setup and cleanup, quick cleaning, and cordless convenience for additional time savings

▶ **CUSTOMIZE YOUR MACHINE**

A full range of chain knockers and accessories are available



Drill not included

CATALOG NO.	MODEL NO.	DESCRIPTION
64268	K9-102	FlexShaft, K9-102 Global 1¼" - 2" (32 - 50 mm) Pipes Includes: 15 m of ¼" (6 mm) cable and kit*
64278	K9-204	FlexShaft, K9-204 Global 2" - 4" (50 - 100 mm) Pipes Includes: 21.3 m of ⅜" (8 mm) cable and kit**

*K9-102 includes: Knecker, K9-102 1¼" (32 mm)
Knecker, K9-102 2" (50 mm)
Lubricant, FlexShaft 118 ml
Accessory, PVC 32 mm attachment
Accessory, PVC 40 mm attachment
Tool, Hex Key 4 mm T-handle
Tool, Hex Key 3 mm T-handle
RIDGID tool bag
Manual pack, K9-102 & K 9-204

**K9-204 includes: Knecker, K9-204 2" (50 mm)
Knecker, K9-204 4" (100 mm)
Lubricant, FlexShaft 118 ml
Tool, Hex Key 4 MM T-handle
Tool, Hex Key 3 MM T-handle
RIDGID tool bag
Manual pack, K9-102 & K 9-204

Accessories

CATALOG NO.	DESCRIPTION
64283	FlexShaft Knecker, for ¼" (6 mm) cable, 32 - 50 mm pipe, single chain, carbide tip
64288	FlexShaft Knecker, for ¼" (6 mm) cable, 50 mm pipe, 2 chain, carbide tip
64293	FlexShaft Knecker, for ¼" (6 mm) cable, 32 - 50 mm pipe, single chain
64298	FlexShaft Knecker, for ¼" (6 mm) cable, 50 mm pipe, 2 chain
64308	FlexShaft Knecker, for ⅜" (8 mm) cable, 50 mm pipe, 2 chain, carbide tip
64313	FlexShaft Knecker, for ⅜" (8 mm) cable, 75 mm pipe, 3 chain, carbide tip
64318	FlexShaft Knecker, for ⅜" (8 mm) cable, 100 mm pipe, 3 chain, carbide tip
64323	FlexShaft Knecker, for ⅜" (8 mm) cable, 50 mm pipe, 2 chain
64328	FlexShaft Knecker, for ⅜" (8 mm) cable, 75 mm pipe, 3 chain
64333	FlexShaft Knecker, ⅜" (8 mm) cable, 100 mm pipe, 3 chain
64338	RIDGID FlexShaft Lubricant, 238 ml, 12 per case
64343	FlexShaft ¼" (6 mm) Assembly, cable, sheath, couplings, 15 m
64348	FlexShaft ⅜" (8 mm) Assembly, cable, sheath, couplings, 21.3 m
64363	Accessory, 32 mm RIDGID wallpipe
64368	Accessory, 40 mm RIDGID wallpipe
64643	Accessory, ¼" (6 mm) sheath stock
64648	Accessory, ⅜" (8 mm) sheath stock



Chain Knockers

- All pipe types
- For soft blockages and grease
- Catalog No's. 64293, 64298, 64323, 64328 & 64333



Carbide Tipped Chain Knockers

- Hard walled pipes
- For soft blockages, grease, scale and roots
- Catalog No's. 64283, 64288, 64308, 64313 & 64318



WATER JETTERS



RESTORE DRAINS TO FREE-FLOWING CAPACITY

RIDGID® Water Jetters fully clear grease and soft blockage obstructions in both residential and commercial applications. Available in both electric and gas models, these machines propel a flexible hose through drain lines to blast through sludge, soap and grease blockages with 1160 to 3000 PSI (80 bar to 205 bar). As you pull the hose back, it scrubs the line flushing debris away and restoring drains to their free-flowing capacity.

KEY FEATURES

- | GAS AND ELECTRIC MODELS AVAILABLE
- | 1160 TO 3000 PSI
- | BEST SOLUTION FOR SOFT BLOCKAGES

DRAIN CLEANING WATER JETTERS



KJ-1590 II



KJ-2200



KJ-3100

APPLICATION CHART

	SINK LINES		
	FLOOR/SECONDARY DRAINS		
	LATERALS		MAIN LINES
LINE SIZE:	32 - 150 mm	32 - 150 mm	50 - 250 mm
MAXIMUM PRESSURE:	1160 PSI / 80 bar	2200 PSI / 150 bar	3000 PSI / 205 bar
FLOW:	15 l/min	9 l/min	21 l/min
POWERED BY:	Electric 2.2 kW	Gas Engine	Gas Engine
HORSEPOWER:	2.2 kW	6.5 HP	16 HP
WEIGHT:	52 kg	29.5 kg	125 kg



KJ-1590 II WATER JETTER

CLEAR 1¼" TO 6" (32 TO 150 MM) DRAIN LINES

The RIDGID KJ-1590 II water jetter effectively cleans lines with an actual working pressure of 1160 PSI (80 bar) and a flow of 4 GPM (15 l/m). Easily navigate difficult bends or traps with the standard pulse action feature. Its 2.2 kW motor draws a maximum of 14 amps and can run on most standard 230 V circuits. Purpose built with quality components, the KJ-1590 II is equipped with heavy wheels to roll the jetter to the job site with the greatest ease.

► **POWERFUL PRESSURE**

Actual working pressure of 1160 psi (80 bar) and flow of 4 GPM (15 l/min)

► **ELECTRICAL REQUIREMENTS**

Powerful 2.2 kW motor draws a maximum of 14 amps and can run on most standard 230 V circuits

► **EASY OPERATION**

Thrust propels the hose down the line

► **CLEAN BEYOND THE DRAIN**

Optional power washer package cleans cables, tools and heavily soiled equipment

CATALOG NO.	MODEL NO.	DESCRIPTION
35511	KJ-1590 II	230 V Standard Jetter with Pulse: Propulsion Nozzle ¼", and Penetrating Nozzle ¼", 20 m x ¼" hose



KJ-2200 WATER JETTER

CLEAR 1¼" TO 6" (32 TO 150 MM) DRAIN LINES

The RIDGID® KJ-2200 Water Jetter effectively cleans lines with an actual working pressure of 2200 PSI (150 bar) and a flow of 2.4 GPM (9 l/m). Activate the KJ-2200's pulse action to easily navigate difficult bends or traps. Its new and improved 6.5 HP recoil start gasoline engine starts easily every time and features: on/off switch, choke and throttle controls, and easy access oil fill and dip stick. Purpose built with quality components, the KJ-2200 features a triplex pump with a corrosion-resistant forged brass head. The control valve lets you quickly and easily adjust water pressure.



Model KJ-2200-C



Model KJ-2200

- ▶ **POWERFUL PRESSURE**
Actual working pressure of 2200 psi (150 bar) and flow of 2.4 GPM (9 l/min)
- ▶ **GAS ENGINE**
6.5 HP recoil start gasoline engine starts easily every time
- ▶ **EASY OPERATION**
Thrust propels the hose down the line
- ▶ **TOTAL CONTROL**
Includes FV-1 foot valve so you can control the jetting action at the drain while leaving the jetter outdoors
- ▶ **CLEAN BEYOND THE DRAIN**
Optional power washer package cleans cables, tools and heavily soiled equipment

CATALOG NO.	MODEL NO.	DESCRIPTION
63877	KJ-2200	Standard Jetter with Pulse: H-61, H-62, and H-64 ¼" NPT Nozzles, H-71 and H-72 ¼" NPT Nozzles, 75' x ¾" (22.8 m x 4.8 mm) Trap Hose, FV-1 Foot Valve, Nozzle Cleaning Tool and H-1235 Wash Wand Hose ½" x 35' (10.7 m x 12.7 mm)
63882	KJ-2200-C	Standard Jetter Package above with: H-30 Cart and 110' x ¼" (33 m x 4.8 mm) Jet Hose



KJ-3100 WATER JETTER

CLEARs 2" TO 10" (50 TO 250 MM) DRAIN LINES

The RIDGID® Model KJ-3100 portable water jetter gives you 3000 psi (205 bar) actual working pressure to handle large commercial and industrial applications. With its removable hose reel, there is no need to purchase expensive portable hose reels. Standard packages come equipped to handle indoor and remote applications. Completely remove the hose reel to ease loading onto service trucks. Simply rotate the hose reel forward to gain full access to the engine's gas tank and air filter. The RIDGID KJ-3100 is one of the most maneuverable jetters on the market. The unit, on its unique two-wheeled cart, easily fits through standard size doors and can negotiate tight turns with the greatest of ease.

▶ **POWERFUL PRESSURE**

Actual working pressure of 3000 psi (205 bar) and flow of 5.5 GPM (21 l/min)

▶ **REMOVABLE HOSE REEL**

Eliminates the need to purchase expensive portable hose reels

▶ **SUPERIOR MANEUVERABILITY**

Unique two-wheeled cart easily fits through standard size doors

▶ **GAS ENGINE**

16 HP recoil start gasoline engine starts easily every time

▶ **CLEAN BEYOND THE DRAIN**

Power wash package and chemical injector system cleans cables, tools and heavily soiled equipment



CATALOG NO.	MODEL NO.	DESCRIPTION
37413	KJ-3100	Standard Jetter with Pulse – H-111 and H-112 ¼" NPT Nozzles – H-38 Hose Reel with 200' x ¾" (61 m x 10 mm) ID Jet Hose – 50' x ¾" (15 m x 10 mm) ID Jet/Wash Hose – FV-1 Foot Valve – Nozzle Cleaning Tool – HW-30 Wash Wand – RR3000 Root Ranger Root Cutting Nozzle – HF-4 Quick Connect Hose



RR 3000 Nozzle
Catalog No. 16713



JETTER NOZZLES

The RIDGID Jetter Nozzles come in different sizes and can be either "general use" or "specialized use". All have their specific differences which make them suitable for either general cleaning or for clearing even the toughest blockages.

► **PROPULSION NOZZLE**

General-purpose nozzle that works well in most applications. Features three reverse thrusters for maximum propulsion to jet long distances. Use this nozzle for most applications.



► **PENETRATING NOZZLE**

Penetrating nozzle features an additional forward pointing jet that blasts a hole in solid ice or sludge blockages. Three reverse jets provide propulsion.



► **DROP HEAD NOZZLE**

Allows jetter hose to negotiate difficult bends and traps. Three reverse thrusters provide propulsion.



► **SPINNING NOZZLE**

Spinning action cleans the entire interior of pipe surface. Three reverse jets provide propulsion.



► **ROOT RANGER® NOZZLE**

Rear-facing turbojet produces a powerful, concentrated stream of water that shears root obstructions from drain walls.





REELS & CAMERAS

THE INDUSTRY STANDARD FOR TOUGHNESS AND EASE OF USE

RIDGID® reels and cameras deliver a crisp in-pipe image that is always upright. Compact, lightweight and user-friendly, these reels and cameras have a cable that is stiff enough to push out long runs, yet flexible enough to make tight turns. With Wi-Fi connectivity, these reels and cameras are compatible with all RIDGID monitors as well as smartphones and tablets.

KEY FEATURES

- | RUGGED LED LIGHTS FOR EXCEPTIONAL VIEWING
- | COMPATIBLE WITH ANY SEESNAKE MONITOR OR RECORDER
- | SELF-LEVELING FOR UPRIGHT IMAGES

RIDGID® SEESNAKE®

SELECTING THE RIGHT CAMERA SYSTEM FOR YOU

The best decisions are made from an abundance of information and a thorough understanding of your options. Buying a RIDGID SeeSnake camera system is no different.

A camera's rated pipe capacity can be one of the first things customers look at when determining which system fits their needs. We define pipe capacity as the range of pipe sizes where a given SeeSnake system performs best. This means we rate where it can physically fit and where it can practically operate, both in terms of its ability to deliver a useful image that illuminates a pipe's interior and where it may be pushed to complete an inspection.

On the large end, our rating ends where we feel the cable has enough stiffness to push through a given diameter while supplying sufficient light to create a usable image of the pipe's surface. A camera can readily be used beyond its rated capacity, but the experience of pushing the cable will be more difficult and may yield less-satisfying results. High dynamic range (HDR) image sensors on TruSense™ cameras illuminate many pipes that are wider than the rated pipe capacity, leaving push cable stiffness to be the limiting factor for those systems. More flexible cables navigate turns more readily, but the lack of stiffness of these cables limits the distance they can be pushed, even in straight runs. Stiffer push cables will push farther in straight runs but are more quickly limited when the pipe makes multiple turns.

When choosing an inspection camera, it is important to match the expected job requirements with a camera system's attributes:

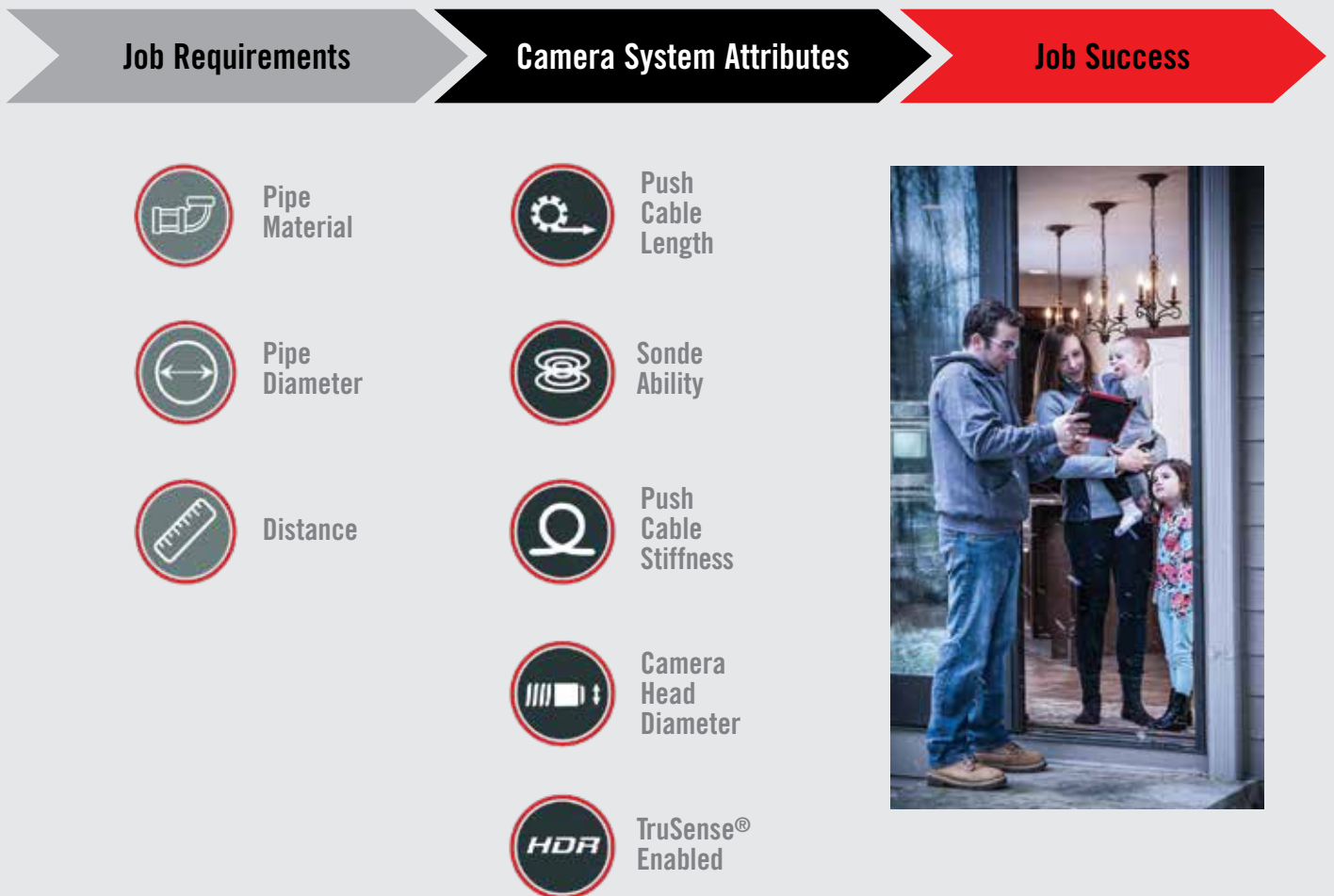

DIAGNOSTICS
CAMERA REELS

RIDGID® SEESNAKE® POWERED BY

TruSense™
RIDGID.EU/TRUSENSE



NEW

THE FIRST TRUE DATA-ENABLED PLUMBING DIAGNOSTIC CAMERAS

RIDGID® SeeSnake® cameras with TruSense™ technology bring powerful data capability to plumbing diagnostics. TruSense establishes a two-way datalink path between the camera head and a connected SeeSnake CSx series Wi-Fi enabled monitor. With TruSense, advanced sensors on the camera head convey valuable information about the in-pipe environment.

FEATURES

- ▶ Enables two-way data communication between the camera and a CSx series monitor
- ▶ Self-leveling camera models keep the image upright
- ▶ SeeSnake TruSense cameras include a **High Dynamic Range (HDR)** image sensor that takes the next leap forward in diagnostic imaging. A common challenge faced by diagnostic professionals is being able to see far down the pipe as well as the image just in front of the camera's lights. An HDR image sensor expands the camera's dynamic range, allowing a greater ratio of bright and dark areas to be displayed in the same image at the same time without reducing visibility. This means fewer blown-out areas and sections of the pipe that are too dark to see, offering superior clarity and detail.
- ▶ **TiltSense™** is an on-camera inclinometer that is included on SeeSnake TruSense cameras. The inclinometer measures the camera's angle. When connected to a SeeSnake CSx series monitor, the camera can convey the camera's degree of tilt on the monitor display – giving you a useful indicator of the pitch of the pipe.

HDR

TiltSense™



Camera with TruSense



Camera without TruSense

* CSx series digital recording monitors include the RIDGID SeeSnake CS6xVERSA, SeeSnake CS65x, and SeeSnake CS12x



RIDGID® SEESNAKE® STANDARD WITH TRUSENSE™

**INSPECT 2" TO 12" (50 TO 300 MM)
LINES UP TO 325' (99 M)**

The RIDGID SeeSnake Standard has the stiffest push cable and is available in lengths up to 325' (99 m) – making it perfect for long runs, particularly in larger pipes with fewer turns. Now available with TruSense technology - including TiltSense™ and an HDR image sensor – this camera delivers unmatched clarity and performance.

- ▶ **ADVANCED INSPECTION DATA**
Equipped with TiltSense and HDR image sensor
- ▶ **HIGH-INTENSITY LED LIGHTS**
For exceptional viewing and long life
- ▶ **SELF-LEVELING CAMERA**
Crisp, always upright in-pipe images
- ▶ **POWERFUL FLEXMITTER® SONDE**
Compatible with all RIDGID locators

CATALOG NO.	DESCRIPTION
63583	325' (99 m) Standard 35 mm SL TruSense
63603	200' (61 m) Standard 35 mm SL TruSense

Accessories

CATALOG NO.	DESCRIPTION
64497	75 mm Star Guide, 35 mm Camera, Pkg of 20
97852	85 mm Pipe Guide, 35 mm Camera, Pkg of 10
64502	150 mm Pipe Guide, 35 mm Camera, Pkg of 10
93387	Guide Hoop, 35mm Camera, Pkg of 4
97832	75 mm Roller Dolly, up to 6" Pipe
17563	Spanner Wrench, 35 mm

Replacement Parts

CATALOG NO.	DESCRIPTION
63833	35 mm Self-Leveling Camera Head - TruSense
63838	35 mm Fixed Camera Head - TruSense
35103	325' (99 m) SeeSnake Standard Push Cable Assembly
35108	200' (61 m) SeeSnake Standard Push Cable Assembly
64627	Interconnect Cable, 33' (10 m) SeeSnake Standard



RIDGID® SEESNAKE® MINI WITH TRUSENSE™

**INSPECT 1½" TO 8" (40 TO 200 MM)
LINES UP TO 200' (61 M)**

A smaller version of the iconic RIDGID SeeSnake Standard system, the RIDGID SeeSnake Mini comes equipped with TruSense technology featuring TiltSense™ and an HDR image sensor. The Mini features a moderately stiff push cable that strikes a good balance between inspecting long runs and navigating tight turns.

- ▶ **ADVANCED INSPECTION DATA**
Equipped with TiltSense and HDR image sensor
- ▶ **HIGH-INTENSITY LED LIGHTS**
For exceptional viewing and long life
- ▶ **SELF-LEVELING CAMERA**
Crisp, always upright in-pipe images
- ▶ **POWERFUL FLEXMITTER® SONDE**
Compatible with all RIDGID locators



CATALOG NO.	DESCRIPTION
63628	200' (61 m) Mini 30 mm SL TruSense

Accessories

CATALOG NO.	DESCRIPTION
67312	101 mm Star Guide, 30mm Camera, Pkg of 20
95507	75 mm Star Guide, 30 mm Camera, Pkg of 6
97462	Pipe Guide, 30 mm Camera, Pkg of 6
93392	Guide Hoop, 30 mm Camera, Pkg of 4
17558	Spanner Wrench, 30 mm



RIDGID® SEESNAKE® RM200 MAX

**INSPECT 1½" TO 8" (40 TO 200 MM)
LINES UP TO 200' (61 M)**

The stow bin and transport system makes the RIDGID® SeeSnake® rM200 Max camera system one of the most convenient reels on the market. The rM200 D2A configuration uses a moderately stiff 200' (61 m) push cable that provides a good compromise between cable stiffness and ability to navigate turns in the pipe. The rM200 D2B includes 165' (50 m) of our stiffest push cable, coupled with a dual nested spring to navigate tight corners that are not usually passable with such a stiff cable.

► **INTERCHANGEABLE DRUM SYSTEM**

For on-the-job flexibility.

► **BUILT-IN DOCKING SYSTEM**

Compatible with CS12x and CS65x monitors

► **ACCESSORIES INCLUDE**

Pipe guides for better in-pipe imaging and a stow bin for storing tools

► **SELF-LEVELING CAMERA HEAD**

Crisp, always upright in-pipe images



rM200B D2B Drum
Catalog No. 47543



rM200 D2A Drum
Catalog No. 47553

CATALOG NO.	DESCRIPTION
47163	Kit, rM200A 61M SL with CS6x VERSA, 1 Battery and 1 Charger
42353	Reel, SeeSnake MAX rM200A (61 m) w/D2A Drum
47533	Reel, SeeSnake MAX rM200B (50 m) w/D2B Drum

Accessories

CATALOG NO.	DESCRIPTION
47793	36 mm Camera Head, 25mm Camera, Pkg of 1
35338	45 mm Pipe Guide, 25mm Camera, Pkg of 2
97462	60 mm Pipe Guide, 25mm Camera, Pkg of 6
46708	85 mm Pipe Guide, 25mm Camera, Pkg of 2
46713	125 mm Pipe Guide, 25mm Camera, Pkg of 2
63868	Spanner Wrench, 25 mm
17553	Various Pipe Guides, 25 mm Camera Head, Set of 5
44038	rM200 Stow Bins
64658	rM200 Stow Bin (Right)
47553	Drum, rM200 D2A PAL
47543	Drum, rM200 D2B PAL



RIDGID® SEESNAKE® COMPACT2

**INSPECT LINES FROM 1½" TO 6" (40 TO 150 MM)
UP TO 100' (30 M)**

The RIDGID® SeeSnake® Compact2 delivers great image quality in a smaller package that's compatible with the RIDGID SeeSnake CS6x VERSA monitor. The Compact2 includes a 100' (30 m) flexible push cable that fits in smaller diameter pipes and navigates turns with ease.

► **QUICK-RELEASE DOCKING SYSTEM**

For use with RIDGID SeeSnake CS6x VERSA monitor

► **POWERFUL FLEXMITTER® SONDE**

Longer range preserves the camera's ability to make turns

► **RUGGED METAL FRAME**

Provides a solid base for pushing and retrieving cable

► **SELF-LEVELING CAMERA HEAD**

Crisp, always upright in-pipe images



CATALOG NO.	DESCRIPTION
48118	SeeSnake Compact2 System with CS6x VERSA, 1 Battery and 1 Charger
48098	SeeSnake Compact2 (Reel Only)

Accessories

CATALOG NO.	DESCRIPTION
47793	36 mm Pipe Guide, 25 mm Camera, Pkg of 1
35338	45 mm Pipe Guide, 25 mm Camera, Pkg of 2
97462	60 mm Pipe Guide, 25 mm Camera, Pkg of 6
46708	85 mm Pipe Guide, 25 mm Camera, Pkg of 2
46713	125 mm Pipe Guide, 25 mm Camera, Pkg of 2
63868	Various Pipe Guides, 25 mm Camera Head, Set of 5
17553	Spanner Wrench, 25 mm
45368	AC Battery Adapter, 230 V
43323	18 V Advanced Lithium 2.0 Ah Battery
61743	18 V Advanced Lithium 2.0 Ah Battery, Set of 2 (incl. 1 Charger)
43328	18 V Advanced Lithium 4.0 Ah Battery
45433	18 V Advanced Lithium 4.0 Ah Battery, Set of 2 (incl. 1 Charger)
43333	18 V Advanced Lithium Battery Charger, 230 V





RIDGID® SEESNAKE® COMPACT C40, WITH TRUSENSE™

INSPECT 40 TO 150 MM LINES UP TO 40 M

The RIDGID® SeeSnake® Compact C40 offers similar performance to the SeeSnake Compact2, and adds the TruSense Technology to the Package, offering High Dynamic Range and TiltSense. Compact C40 features 40 m flexible push cable, ideal for expanding small or restricted branch lines with tight turns.

- ▶ **HIGH-INTENSITY LED LIGHTS**
For exceptional viewing and long life
- ▶ **POWERFUL FLEXMITTER® SONDE**
Compatible with all RIDGID locators
- ▶ **QUICK RELEASE DOCKING SYSTEM**
All-in-One Monitor Compatibility (with CS6xVERSA)
- ▶ **ADVANCED INSPECTION DATA**
Self-leveling Camera Head with TruSense Technology, offering HDR and TiltSense
- ▶ **RUGGED COMPACT FORMFACTOR**
Compatible with all SeeSnake CSx Monitors

CATALOG NO.	DESCRIPTION
63668	SeeSnake Compact C40 (Reel Only) with TruSense
64208	SeeSnake Compact C40 System with CS6x VERSA, 1 Battery and 1 Charger



Accessories

CATALOG NO.	DESCRIPTION
47793	36 mm Pipe Guide, 25 mm Camera, Pkg of 1
35338	45 mm Pipe Guide, 25mm Camera, Pkg of 2
97462	60 mm Pipe Guide, 25mm Camera, Pkg of 6
46708	85 mm Pipe Guide, 25mm Camera, Pkg of 2
46713	125 mm Pipe Guide, 25mm Camera, Pkg of 2
63868	Various Pipe Guides, 25mm Camera Head, Set of 5
17553	Spanner Wrench, 25 mm
45368	AC Battery Adapter, 230 V
43323	18 V Advanced Lithium 2.0 Ah Battery
61743	18 V Advanced Lithium 2.0 Ah Battery, Set of 2 (incl. 1 Charger)
43328	18 V Advanced Lithium 4.0 Ah Battery
45433	18 V Advanced Lithium 4.0 Ah Battery, Set of 2 (incl. 1 Charger)
43333	18 V Advanced Lithium Battery Charger, 230 V



RIDGID® SEESNAKE® COMPACT M40, WITH TRUSENSE™

INSPECT 40 TO 200 MM LINES UP TO 40 M

The RIDGID® SeeSnake® Compact M40 combines the best of SeeSnake Mini and SeeSnake Compact. Adding the TruSense Technology to this package and it creates a very comprehensive, easy-to-use inspection system. The moderately stiff push cable provides a good compromise between stiffness and the ability to navigate turns. The Compact M40 features a 40 m push cable that is ideal for longer run expanding lateral lines with a few turns.

- ▶ **HIGH-INTENSITY LED LIGHTS**
For exceptional viewing and long life
- ▶ **POWERFUL FLEXMITTER® SONDE**
Compatible with all RIDGID locators
- ▶ **QUICK RELEASE DOCKING SYSTEM**
All-in-One Monitor Compatibility (with CS6xVERSA)
- ▶ **ADVANCED INSPECTION DATA**
Self-leveling Camera Head with TruSense Technology, offering HDR and TiltSense
- ▶ **RUGGED COMPACT FORMFACTOR**
Compatible with all SeeSnake CSx Monitors



CATALOG NO.	DESCRIPTION
63673	SeeSnake Compact M40 (Reel Only) with TruSense
64208	SeeSnake Compact C40 System with CS6x VERSA, 1 Battery and 1 Charger

Accessories

CATALOG NO.	DESCRIPTION
47793	36 mm Pipe Guide, 25 mm Camera, Pkg of 1
35338	45 mm Pipe Guide, 25mm Camera, Pkg of 2
97462	60 mm Pipe Guide, 25mm Camera, Pkg of 6
46708	85 mm Pipe Guide, 25mm Camera, Pkg of 2
46713	125 mm Pipe Guide, 25mm Camera, Pkg of 2
63868	Various Pipe Guides, 25mm Camera Head, Set of 5
17553	Spanner Wrench, 25 mm
45368	AC Battery Adapter, 230 V
43323	18 V Advanced Lithium 2.0 Ah Battery
61743	18 V Advanced Lithium 2.0 Ah Battery, Set of 2 (incl. 1 Charger)
43328	18 V Advanced Lithium 4.0 Ah Battery
45433	18 V Advanced Lithium 4.0 Ah Battery, Set of 2 (incl. 1 Charger)
43333	18 V Advanced Lithium Battery Charger, 230 V

RIDGID® SEESNAKE® MICROREEL™

**INSPECTS 1½" TO 3" OR 4" (40 TO 75 OR 100 MM)*
LINES UP TO 100' (30 M)**

The RIDGID SeeSnake microReel is a budget-friendly option for pipe inspection, particularly for those that do not require a self-leveling camera head. The microReel passes 90-degree bends in most 2" (50 mm) lines. Lightweight and portable, the microReel is compatible with the micro CA-350(x) and all SeeSnake monitors.

- ▶ **EASY TRANSPORT**
Lightweight and compact
- ▶ **REMOVABLE DRUM**
Can be swapped with microDrain™ and nanoReel™ drums
- ▶ **GUIDE INCLUDED**
For better in-pipe imaging
- ▶ **MULTI MONITOR COMPATIBILITY**
Use with a SeeSnake monitor or with CA-350(x) inspection camera

* 3" (75 mm) when used with a micro CA-350(x) inspection camera. 4" (100 mm) when used with a SeeSnake monitor.

microReel L100/L100C for SeeSnake Monitor

CATALOG NO.	DESCRIPTION
35138	microReel L100 (SeeSnake) Sonde (PAL)
35213	microReel L100C (SeeSnake) Sonde & Counter (PAL)

microReel L100/L100C for micro CA-350 and CA-350x

CATALOG NO.	DESCRIPTION
40803	microReel L100 with micro CA-350 System (PAL)
40813	microReel L100C with micro CA-350 System (PAL)
56668	microReel L100 with micro CA-350x System (PAL)
56673	microReel L100C with micro CA-350x System (PAL)
35148	microReel L100 (micro CA-350) Sonde (PAL)
35218	microReel L100C (micro CA-350) Sonde & Counter (PAL)

Accessories

CATALOG NO.	DESCRIPTION
35338	45 mm Pipe Guide, 25mm Camera, Pkg of 2
40598	60 mm Pipe Guide, MicroReel, Pkg of 1
17553	Spanner Wrench, SS 25 Handleless
33108	Interconnect Cable for SeeSnake Monitor
33113	Interconnect Cable CA-350(x)
55903	micro CA-350 Inspection Camera
63888	micro CA-350x Inspection Camera
35228	Drum, MicroReel L100 (PAL)
35248	Drum, MicroReel L100C (PAL)





RIDGID® SEESNAKE® MICRODRAIN™

**INSPECT 1¼" TO 3" OR 4" (32 TO 75 OR 100 MM)*
LINES UP TO 65' (20 M)**

The RIDGID SeeSnake microDrain is a specialty system built for small-diameter inspections like toilet traps, sinks and P-traps. Lightweight and compact, the microDrain is roughly half the size of other inspection systems and uses an extremely flexible cable to effectively navigate tight turns.

- ▶ **COMPACT SIZE**
Lightweight and compact
- ▶ **REMOVABLE DRUM**
Can be swapped with microReel™ and nanoReel™ drums
- ▶ **GUIDE INCLUDED**
For better in-pipe imaging
- ▶ **MULTI MONITOR COMPATIBILITY**
Use with a SeeSnake monitor or with CA-350(x) inspection camera

* 3" (75 mm) when used with a micro CA-350(x) inspection camera. 4" (100 mm) when used with a SeeSnake monitor.



CATALOG NO.	DESCRIPTION
37513	microDrain D65S Reel (SeeSnake) Sonde (PAL)
37518	microDrain D65S Reel (micro CA-350) Sonde (PAL)
40793	microDrain D65S with micro CA-350 System (PAL)
56683	microDrain D65S with micro CA-350x System (PAL)

Accessories

CATALOG NO.	DESCRIPTION
34318	42 mm Pipe Guide, 22 mm Camera, Pkg of 2
40593	36 mm Pipe Guide, 22 mm Camera, Pkg of 2
53088	Spanner Wrench, SS 22 Handleless
33108	Interconnect Cable for SeeSnake Monitor
33113	Interconnect Cable for micro CA-350
55903	micro CA-350 Inspection Camera
63888	micro CA-350x Inspection Camera
37528	Drum, microDrain D65S (PAL)



RIDGID® SEESNAKE® NANOREEL™

**INSPECTS 1" TO 2" (25 TO 50 MM)
LINES UP TO 85' (25 M)**

The RIDGID SeeSnake nanoReel™ is perfect for long-run, small diameter applications. Previously only accessible with boroscopes, the nanoReel system is a great option for inspecting boiler tubes, supply lines, sprinkler systems and a wide array of specialty applications. It passes 90-degree bends in most 30 mm lines.

- ▶ **COMPACT SIZE**
Stores easily on a truck
- ▶ **REMOVABLE DRUM**
Can be swapped with microDrain™ and microReel™ drums
- ▶ **GUIDE INCLUDED**
For better in-pipe imaging
- ▶ **MULTI MONITOR COMPATIBILITY**
Use with a SeeSnake monitor or with CA-350(x) inspection camera

CATALOG NO.	DESCRIPTION
40013	nanoReel N85S (SeeSnake) Sonde (PAL)
40003	nanoReel N85S (micro CA-350) Sonde (PAL)
40823	nanoReel N85S with micro CA-350 System (PAL)
56688	nanoReel N85S with micro CA-350x System (PAL)

Accessories

CATALOG NO.	DESCRIPTION
42778	30mm and 25mm Pipe Guide Set, 15.5mm Camera Head, Pkg of 2
40448	Drum, nanoReel N85S (PAL)
55903	micro CA-350 Inspection Camera
63888	micro CA-350x Inspection Camera
33108	Interconnect Cable for SeeSnake Monitor
33113	Interconnect Cable for micro CA-350

SIMILAR APPLICATIONS: SYSTEM DIFFERENCES

NANOREEL™ AND MICRODRAIN™ — SPECIALITY SMALL LINES, HIGH FLEXIBILITY



nano *Reel*



Ultra Flex Push Cable



15 mm Fixed



25 m



Integrated Sonde



micro *Drain*



High Flex Push Cable



22 mm Fixed



20 m



Integrated Sonde

MICROREEL™, COMPACT 2 AND COMPACT C40 — MID-SIZE PIPES, MODERATE FLEXIBILITY



micro *Reel*



Mid Flex Push Cable



25 mm Fixed



30 m



Integrated Sonde



Compact *2*



Mid Flex Push Cable



25 mm Self Leveling



30 m



FlexMitter® Sonde



COMPACT *C40*
with TruSense™



Mid Flex Push Cable



25 mm HDR Self Leveling



40 m



FlexMitter® Sonde



TiltSense™

RM200 D2A, COMPACT M40 AND SEESNAKE® MINI — MID-SIZE PIPES, MODERATE/STIFF FLEXIBILITY



rM200 D2A



Mid-Stiff Flex Push Cable



25 mm Self-Leveling



61 m



FlexMitter® Sonde



COMPACT *M40*
with TruSense™



Mid-Stiff Flex Push Cable



25 mm HDR Self Leveling



40 m



FlexMitter® Sonde



TiltSense™



MINI
with TruSense™



Mid-Stiff Flex Push Cable



30 mm HDR Self-Leveling



61 m



FlexMitter® Sonde



TiltSense™

RM200 D2B AND SEESNAKE STANDARD — LONG RUNS, LARGE PIPES, STIFFEST



rM200 D2B



Stiff Push Cable



25 mm Self-Leveling



50 M



FlexMitter® Sonde



STANDARD
with TruSense™



Stiff Push Cable



35 mm HDR Self-Leveling



61 m / 99 m



FlexMitter® Sonde



TiltSense™



MONITORS & RECORDERS

TOTALLY CONNECTED.

The entire line of RIDGID® SeeSnake® Digital Monitors comes equipped with Wi-Fi connectivity. Stream inspections to your iOS or Android device with the free HQx Live app. Every RIDGID SeeSnake Monitor integrates seamlessly with our SeeSnake Reels and are optimized to work with our TruSense enabled Reels.

KEY FEATURES

- | WI-FI CONNECTIVITY – STREAM TO A SECOND SCREEN
- | SMARTER REPORTING – GENERATE DETAILED REPORTS IN THE FIELD
- | SEAMLESS INTEGRATION – COMPATIBLE WITH ALL RIDGID SEESNAKE REELS



RIGID® SEESNAKE® CS6x VERSA DIGITAL RECORDING MONITOR

IMPROVING JOBSITE ERGONOMICS WITH HIGH AND LOW POSITIONS FOR OPTIMAL VIEWING EFFICIENCY

The RIDGID® SeeSnake® CS6x Versa™ is the flexible, efficient solution for plumbing inspections. The CS6x Versa works with all SeeSnake camera reels and easily docks onto Compact series reels. The frame allows the monitor to be tilted to the optimal viewing angle, and a quick-release mount lets the monitor be placed in a high or low viewing position to suit all jobsite conditions.



► CONVENIENT, VERSATILE VIEWING SYSTEM

Create the optimal viewing angle for your inspection, and use with a Compact series reel for an all-in-one workflow

► ENHANCED WI-FI CONNECTIVITY

Stream or record inspections to an iOS or Android device with the free HQx Live app

► PROFESSIONAL REPORTS

Capture images and video to a USB drive, and deliver to customers right from the jobsite

► DAYLIGHT VIEWABLE DISPLAY WITH SUNSCREEN

Provides a crisp, clear in-pipe image in all lighting conditions

CATALOG NO.	DESCRIPTION
64943	CS6x VERSA Digital Recording Monitor with Wi-Fi
65163	CS6x VERSA with 1 Battery and 1 Charger
45368	AC Battery Adapter, 230 V
43323	18 V Advanced Lithium 2.0 Ah Battery
61743	18 V Advanced Lithium 2.0 Ah Battery, Set of 2 (incl. 1 Charger)
43328	18 V Advanced Lithium 4.0 Ah Battery
45433	18 V Advanced Lithium 4.0 Ah Battery, Set of 2 (incl. 1 Charger)
43333	18 V Advanced Lithium Battery Charger, 230 V



DIAGNOSTICS DIGITAL REPORTING MONITORS



RIDGID® SEESNAKE® CS65x DIGITAL REPORTING MONITOR

INTERNAL SOLID STATE DRIVE LETS YOU STORE IMAGES AND VIDEOS FROM MULTIPLE JOBS

The RIDGID SeeSnake CS65x digital reporting monitor makes reporting easy. Directly capture inspection media on up to two USB drives as well as the CS65x's internal storage. The water-resistant, built-in keyboard and on-board reporting software let you enhance captured media with overlaying notes and customer information right from the job site.

► **ENHANCED CONNECTIVITY**

Wi-Fi lets you stream or record to an iOS or Android phone or tablet

► **USB PORTS**

For easy delivery of multiple copies of an inspection

► **INTERNAL GPS**

Geotag media with positional information when available

► **INTERNAL STORAGE**

Internal 128 Gb solid state drive offers plenty of storage



SeeSnake rM200 with CS65x
docked for easy transport

CATALOG NO.	DESCRIPTION
54368	CS65x Digital Reporting Monitor with Wi-Fi
57133	CS65x with 1 Battery and 1 Charger
45368	AC Battery Adapter, 230 V
43323	18 V Advanced Lithium 2.0 Ah Battery
61743	18 V Advanced Lithium 2.0 Ah Battery, Set of 2 (incl. 1 Charger)
43328	18 V Advanced Lithium 4.0 Ah Battery
45433	18 V Advanced Lithium 4.0 Ah Battery, Set of 2 (incl. 1 Charger)
43333	18 V Advanced Lithium Battery Charger, 230 V



RIDGID® SEESNAKE® CS12x DIGITAL RECORDING MONITOR

**LARGEST SCREEN. LONGEST BATTERY LIFE.
HIGHEST RESOLUTION.**

The RIDGID SeeSnake CS12x Monitor features dual battery power for maximum runtime on the job. It's 12.1" screen with a 1024 x 768 resolution delivers a high-contrast display that is still crisp and clear in the daylight. The CS12x comes equipped with our most powerful processor for fast start-up time and high-speed performance.



Bluetooth



▶ **ENHANCED CONNECTIVITY**

Wi-Fi lets you stream or record to an iOS or Android phone or tablet

▶ **DUAL BATTERY POWER**

Two batteries can be installed for maximum runtime

▶ **POWERFUL PROCESSOR**

Faster start-up and performance

▶ **LARGE 12.1" DISPLAY**

With a crisp, clear 1024 x 768 resolution



CATALOG NO.	DESCRIPTION
57283	CS12x Digital Recording Monitor with Wi-Fi
57293	CS12x Monitor with 2 Batteries and 1 Charger
45368	AC Battery Adapter, 230 V
43323	18 V Advanced Lithium 2.0 Ah Battery
61743	18 V Advanced Lithium 2.0 Ah Battery, Set of 2 (incl. 1 Charger)
43328	18 V Advanced Lithium 4.0 Ah Battery
45433	18 V Advanced Lithium 4.0 Ah Battery, Set of 2 (incl. 1 Charger)
43333	18 V Advanced Lithium Battery Charger, 230 V



HQ SOFTWARE PLATFORMS



RIDGID HQ Software is supplied standard on a USB with all SeeSnake Reels and all SeeSnake Monitors.

SEESNAKE HQ™ DIGITAL INSPECTION SOFTWARE

HQ is a free software tool that helps you collect digital pipe inspection content and impress your customers with easy-to-create, professional looking reports.

SeeSnake HQ Software streamlines critical and routine updates which help improve and prolong the life of your equipment. HQ also gives you the ability to manage jobs and generate reports for customers. HQ Software is preloaded onto the 8 GB USB drive, included with all CSx monitors.

REPORT

Use HQ to document, organize and edit jobs, store customer information, customize and distribute reports in multiple formats, and update equipment software. Upload your complete reports directly to your RIDGIDConnect.com account with one mouse click.

COMPATIBILITY

HQ can be installed on PCs running Windows 7 or later. The software is translated into over 15 languages and localized for use worldwide. The 8 GB USB drive included with all SeeSnake monitors has HQ preloaded. Insert the USB drive into a PC to begin installation.

RIDGID® SEESNAKE® HQx® LIVE DIGITAL INSPECTION SOFTWARE

HQx Live is a free app that works with your SeeSnake CSx series Wi-Fi enabled monitor to share inspections with your customers. Available on iOS™ and Android™ devices, HQx Live provides second screen flexibility, allowing you to stream live video directly to a mobile device. You can also capture and share photos, PhotoTalk™ media, and video. If your camera is equipped with TruSense technology, the TiltSense icon will appear on your captured media.



*Messaging and data rates may apply. Some Android devices may not be able to send and receive data over a cellular network while connected to a CSx monitor over Wi-Fi. iOS is a trademark or registered trademark of Cisco in the U.S. and other countries and is used under license. Android is a trademark of Google LLC.

MONITOR AND RECORD

- ▶ Turn on the monitor's built-in Wi-Fi to quickly connect to an iOS or Android device.
- ▶ Stream inspection footage directly on a connected mobile device.
- ▶ Capture photos, video, and PhotoTalk media, and quickly share over a cellular connection.*
- ▶ Open the Job Gallery to easily view, edit, and manage jobs and inspection media.
- ▶ Quickly annotate media with shareable captions.
- ▶ Email, text, or upload inspection media through a variety of platforms, including YouTube™ (Google account required).
- ▶ Remotely control camera and monitor functions, such as camera brightness and the sonde.
- ▶ Keep your SeeSnake CSx series monitor updated with wireless over-the-air updating.

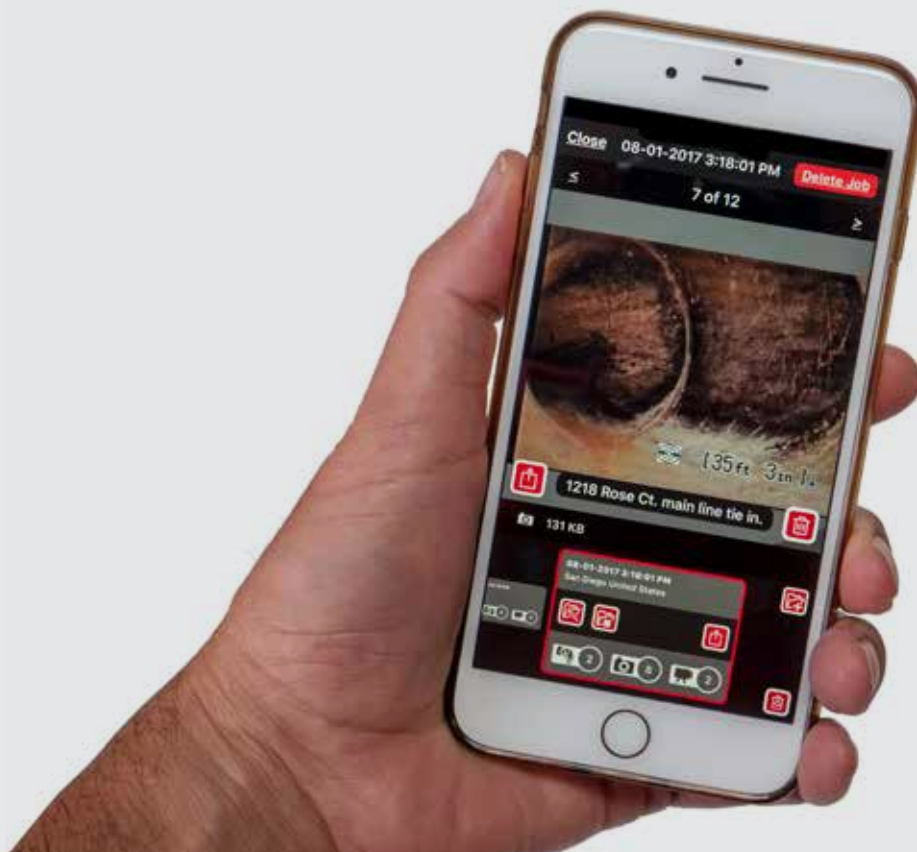

HAND-HELD INSPECTION



ELIMINATE THE GUESSWORK

RIDGID® hand-held inspection cameras reduce the amount of time it takes to detect and diagnose the unreachable. Using a camera and light source attached to a flexible cable, these cameras send live images back to a high visibility digital LCD display.

KEY FEATURES

- | BEST-IN-CLASS IMAGE QUALITY
- | ULTRA-BRIGHT LED TECHNOLOGY
- | IMAGE ROTATION FOR UPRIGHT IMAGES



RIDGID® MICRO CA-25 INSPECTION CAMERA

PERFECT FOR BASIC AND SHORT-RANGE INSPECTION JOBS

The RIDGID micro CA-25 features a fixed* 17 mm waterproof aluminum imager head with four ultra-bright LED lights, bringing superior image quality to its 2.7" Color LCD Screen. It also features Video Out for transferring live images to external devices and 180° Digital Image Rotation for getting upright images.

* Not extendable, with 1,2 m imager cable

- ▶ **COLOR PICTURE**
2.7" Color LCD screen
- ▶ **VIDEO OUT**
Transfer live images to external devices
- ▶ **UPRIGHT IMAGES**
Digital images can be rotated 180 degrees

CATALOG NO.	DESCRIPTION
40043	micro CA-25 Inspection Camera

Replacement Parts

CATALOG NO.	DESCRIPTION
37123	Mirror, Hook and Magnet for 17 mm Camera Head





RIDGID® MICRO CA-150 INSPECTION CAMERA

CAPTURE UP TO 20 STILL IMAGES FOR PLAYBACK ON SCREEN LATER

The RIDGID micro CA-150 Inspection Camera allows you to perform more detailed visual inspections in even harder-to-reach areas. Its ergonomic one-handed grip gives you steady control while four bright LED lights on a waterproof camera head help you diagnose the problem. The micro CA-150 has a large 3.5" color display for crystal clear viewing.

- ▶ **LARGE SCREEN, MORE DETAILS**
3.5" color LCD screen
- ▶ **WATERPROOF IMAGER HEAD W/ EXTENDABLE CABLE (UP TO 9 M)**
Illuminated by four bright LED lights
- ▶ **IMAGE CAPTURE**
Capture up to 20 still images for playback on screen



CATALOG NO.	DESCRIPTION
36848	micro CA-150 Inspection Camera

Accessories

CATALOG NO.	DESCRIPTION
37098	6 mm Imager with 1 m Cable
37093	6 mm Imager with 4 m Cable
37108	90 cm Cable Extension
37113	180 cm Cable Extension

Replacement Parts

CATALOG NO.	DESCRIPTION
37103	17 mm Replacement Imager

RIDGID® MICRO CA-350 INSPECTION CAMERA

12 V RECHARGEABLE LITHIUM-ION BATTERY FOR EXTENDED INSPECTIONS

The RIDGID micro CA-350 inspection camera is great for identifying and documenting leaks behind walls / ceilings and other issues in hard to reach areas. The 12 V rechargeable Lithium-Ion battery gives you longer runtime for extended inspections. Large 3.5" color LCD screen with enhanced features like image rotation and digital zoom make it easier to diagnose potential problems.

- ▶ **LONGER RUN TIME**
12 V rechargeable Lithium-Ion battery for extended inspections
- ▶ **IMAGE / VIDEO RECORDING**
On internal memory or 8 GB SD Card (included)
- ▶ **WATERPROOF 17 MM IMAGER HEAD**
Illuminated by four ultra-bright LED lights
- ▶ **EXTENDED REACH UP TO 30 METERS**
With small diameter SeeSnake® Reels



CATALOG NO.	DESCRIPTION
55903	micro CA-350 Inspection Camera

Included: micro CA-350 with 17 mm imager, battery, charger, USB cable, hook, magnet and mirror accessories, RCA cable, AC adapter, headset with microphone, 8GB SD card.

Accessories

CATALOG NO.	DESCRIPTION
37098	6 mm Imager with 1 m Cable
37093	6 mm Imager with 4 m Cable
37108	90 cm Cable Extension
37113	180 cm Cable Extension
33113	Interconnect Cable for SeeSnake Micro- & NanoReel-series

Replacement Parts

CATALOG NO.	DESCRIPTION
37103	17 mm Replacement Imager
37123	Mirror, Hook and Magnet for 17 mm Camera Head
55183	micro CA-350 12 V Advanced Lithium 2.5 Ah Battery
55198	micro CA-350 12 V Advanced Lithium Battery Charger, 230 V

Compatible Camera Reels

CATALOG NO.	DESCRIPTION
40003	nanoReel® N85S (micro CA-350) PAL
37518	microDrain® D65S Reel (micro CA-350) PAL
35148	microReel® L100 (micro CA-350) Sonde PAL
35218	microReel® L100C (micro CA-350) with Counter PAL





RIDGID® MICRO CA-350x INSPECTION CAMERA

MICRO CA-350 WITH NEW WIRELESS FEATURES AND THE FREE RIDGID VIEW APP

The new micro CA-350x inspection camera with Wi-Fi™ and Bluetooth™ for instant image/video sharing and live second screen viewing!

- ▶ **GO WIRELESS WITH WI-FI™**
For live second screen and instant image/video sharing with the free RIDGID View App.
- ▶ **WIRELESS RECORDING OF AUDIO WITH BLUETOOTH™**
On video inspections with a Bluetooth™ compatible headset.
- ▶ **LONGER RUN TIME**
12 V rechargeable Lithium-Ion battery for extended inspections
- ▶ **IMAGE / VIDEO RECORDING**
On internal memory or 8 GB SD Card (included)
- ▶ **EXTENDED REACH UP TO 30 METERS**
With small diameter SeeSnake® Reels



Download the FREE
RIDGID View App!



CATALOG NO.	DESCRIPTION
63888	micro CA-350x Inspection Camera

Accessories

CATALOG NO.	DESCRIPTION
37098	6 mm Imager with 1 m Cable
37093	6 mm Imager with 4 m Cable
37108	90 cm Cable Extension
37113	180 cm Cable Extension
33113	Interconnect Cable for SeeSnake Micro- & NanoReel-series

Replacement Parts

CATALOG NO.	DESCRIPTION
37103	17 mm Replacement Imager
37123	Mirror, Hook & Magnet for 17 mm Camera Head
55183	micro CA-350 12 V Advanced Lithium 2.5 Ah Battery
55198	micro CA-350 12 V Advanced Lithium Battery Charger

Compatible Camera Reels

CATALOG NO.	DESCRIPTION
40003	nanoReel® N85S (micro CA-350) PAL
37518	microDrain® D65S Reel (micro CA-350) PAL
35148	microReel® L100 (micro CA-350) Sonde PAL
35218	microReel® L100C (micro CA-350) with Counter PAL



ULTRA-SMALL INSPECTIONS WITH THE RIDGID 6 MM IMAGER HEAD

6 MM DIAMETER IMAGER HEAD ACCESSORY FOR MICRO CA-150 / CA-350 / CA-350X

- ▶ Nearly one-third the size of the standard camera head.
- ▶ Enables detailed inspections in very confined spaces.
- ▶ 4 LED lights provide clear images.
- ▶ Fully flexible cable for easy navigation.
- ▶ Available in two cable sizes, 1 m & 4 m.
- ▶ Sleek aluminum construction withstands demanding applications.
- ▶ Accessories for the 6 mm imager head are included for free. The Mirror accessory allows the user to look around corners in the tightest spaces. The Magnet can be used for picking up metal objects in confined spaces. The Centering Ball-accessory allows to center the imager for better view in (tube) lines.
- ▶ Compatible with: RIDGID® micro CA-100, micro CA-150, micro CA-300, micro CA-330, micro CA-350, micro CA-350x, microEXPLORER and SeeSnake micro (digital version).

CATALOG NO.	DESCRIPTION
37093	6 mm Imager with 4 m Cable*
37098	6 mm Imager with 1 m Cable*

*Includes: Centering Ball, Magnet and Mirror Accessory

Replacement Parts

CATALOG NO.	DESCRIPTION
45358	Mirror, Centering Ball & Magnet for 6mm Camera Head



6 mm imager with 1 m cable



6 mm imager with 4 m cable



Mirror, centering ball and magnet for
6 mm camera head



UTILITY LOCATING

FIND IT FASTER.

RIDGID® utility locators feature an easy-to-use visual mapping display that allows you to locate utility lines and sondes or beacons with confidence. These locators can be used with RIDGID SeeSnake® cameras equipped with sonde transmitters to find the camera head during an inspection. They can also be used with a line transmitter to find buried utilities. Remote transmitters attached to a push rod or drain cable can also be found.

KEY FEATURES

- | FIND SONDES OR BEACONS UNDERGROUND
- | FIND PLASTIC PIPES WITH INTEGRAL LINE TRACE
- | INDUCE A SIGNAL TO LOCATE UTILITIES

UTILITY LOCATING EQUIPMENT

RIDGID® SEEKTECH® LOCATING RECEIVERS

RIDGID locating receivers give users an accurate and instantly intuitive way to locate sondes and trace utility lines. Powered by an omnidirectional antenna system and real-time signal processing, RIDGID receivers provide an easy-to-use visual mapping display that allows you to locate with confidence. Use with a SeeSnake® camera equipped with a sonde transmitter to locate the camera head during an inspection, or use with a line transmitter to find buried utilities.



SeekTech SR-60



SeekTech SR-24



SeekTech SR-20



NaviTrack Scout®

CATALOG NO.	30123	46393	21943	19243
OMNIDIRECTIONAL MAPPING DISPLAY	Yes	Yes	Yes	Yes
USER-DEFINED FREQUENCIES	Yes - up to 93 kHz	Yes up to 35 kHz	Yes up to 35 kHz	No
NUMBER OF ACTIVE LINE TRACE FREQUENCIES	All up to 93 kHz	All up to 35 kHz	All up to 35 kHz	3
SONDE FREQUENCIES	All up to 93 kHz	All up to 35 kHz	All up to 35 kHz	4
PASSIVE SEARCH	OmniSeek (searches all passive bands at once)	OmniSeek (searches all passive bands at once)	OmniSeek (searches all passive bands at once)	50/60 Hz
DEPTH	Continuous	Continuous	Continuous	Semi-Continuous
WEIGHT W/BATTERIES	5.4 lb/2.5 kg	4.1 lb/1.9 kg	4 lb/1.8 kg	3 lb/1.4 kg
BLUETOOTH®	No	Yes	No	No
POWER SOURCE	4 C-cell	4 C-cell	4 C-cell	4 C-cell

RIDGID SEEKTECH LINE TRANSMITTERS

Accurately trace buried utilities by applying a signal with a RIDGID SeekTech ST series transmitter. All transmitters have multiple frequency options and are capable of applying a signal by direct connection and induction. Powerful 5 W and 10 W transmitters apply a strong signal for easy locates.



SeekTech ST-33Q+



SeekTech ST-510



SeekTech ST-305

CATALOG NO.	49343R	21953	21948R
MAX POWER OUTPUT	10 W	10 W	5 W
DIGITAL DISPLAY	Yes	Yes	No
LINE TRACE FREQUENCIES	All up to 93 kHz	Selections up to 93 kHz	4
INDUCTIVE FREQUENCIES	8 kHz or 33 kHz	4	3
SIMULTANEOUS TRANSMIT 2 LINE FREQUENCIES	No	No	Yes
WEIGHT W/ BATTERIES	5.4 kg (18 V) / 5.7 kg (D-cell)	3.6 kg	1.3 kg
BLUETOOTH®	Yes	No	No
POWER SOURCE	18 V/6 D-cell/External*	8 D-cell/External*	6 C-cell

*External power source is supplied by user

RIDGID® SEEKTECH® SR-60 LOCATOR

TRACE ANY FREQUENCY FROM 10 HZ TO 93 KHZ

The RIDGID SeekTech SR-60 has the largest display and widest frequency range for quickly and easily locating underground cables and pipes. The SR-60 locator quickly and confidently locates under tough conditions including: poor conductors, poor soil conditions and poor grounding.

► **LOCATING VERSATILITY**

Trace any frequency from 10 Hz to 93 kHz

► **MAPPING DISPLAY**

Shows the utility's estimate position, direction and depth

► **OMNIDIRECTIONAL ANTENNA**

Captures the complete signal field for greater speed and accuracy

► **GRADIENT ANTENNAS**

Deliver left/right guidance and help evaluate signal shape



CATALOG NO.	DESCRIPTION
30123	SeekTech SR-60 Line Locator with batteries and case

Accessories

CATALOG NO.	DESCRIPTION
20973	SeekTech 4" (100 mm) Inductive Signal Clamp
21948R	SeekTech ST-305 Transmitter (5 W)
22388	Replacement Case for SR-60



RIDGID® SR-24 LINE LOCATOR WITH BLUETOOTH® AND GPS

TRACE ANY FREQUENCY FROM 10 HZ TO 35 KHZ

The RIDGID SR-24 is a precision utility locating receiver with integrated GPS and Bluetooth® technology. Its omnidirectional antennas capture the complete signal field, making it easy to acquire the signal and trace its path. The receiver maps the utility's position and direction on its display for an intuitive locating experience. Audio and visual warnings notify the operator if the shape of the signal field is being distorted so action can be taken to avoid mismarking the utility's position.



- ▶ **OMNIDIRECTIONAL ANTENNAS**
Capture the complete signal field for greater speed and accuracy
- ▶ **BUILT-IN GPS**
Track location coordinates for mapping and GIS applications
- ▶ **BLUETOOTH**
Stream data to iOS and Android Mobile Devices or high-precision GPS instruments
- ▶ **LARGE DISPLAY**
Shows the utility's estimated position, direction and depth

CATALOG NO.	DESCRIPTION
46393	SeekTech SR-24 Line Locator with Bluetooth® and GPS (Includes Case)

Accessories

CATALOG NO.	DESCRIPTION
20973	SeekTech 4" (100 mm) Inductive Signal Clamp
49343R	ST-33Q+ Line Transmitter with Bluetooth
22173	Case for SR-20 / SR-24



Use the SR-24 receiver to wirelessly change the transmitted frequency on the ST-33Q+ transmitter.



Download the RIDGID Trax Free





RIDGID® SEEKTECH® SR-20 LOCATOR

TRACE ANY FREQUENCY FROM 10 HZ TO 35 KHZ

The RIDGID SeekTech SR-20 is a lightweight, yet rugged utility line locator that provides all the information you need for locating underground cables and pipes. It features an omnidirectional antenna array and gradient antennas to quickly locate and follow the target line's path.

▶ **OMNIDIRECTIONAL ANTENNAS**

Capture the complete signal field for greater speed and accuracy

▶ **MAPPING DISPLAY**

Shows the utility's estimated position, direction and depth

▶ **GRADIENT ANTENNAS**

Deliver left/right guidance and help evaluate signal shape

▶ **FOLDABLE ANTENNA MAST**

For easy transport and storage

CATALOG NO.	DESCRIPTION
21943	SeekTech SR-20 Line Locator (Includes Case)
26248	SR-20 + ST-305 Transmitter + 4" Inductive Signal Clamp

Accessories

CATALOG NO.	DESCRIPTION
20973	SeekTech 4" (100 mm) Inductive Signal Clamp
21948R	SeekTech ST-305 Transmitter (5 W)



RIDGID® NAVITRACK SCOUT® LOCATOR

LOCATES RIDGID SEESNAKE® IN-LINE TRANSMITTERS, SONDES AND ENERGIZED METALLIC LINES

The NaviTrack Scout locator is designed to solve the most demanding sonde locators using the same omnidirectional locating technology as the full-featured SR® series utility line locators. The NaviTrack Scout offers continuous depth measurement when the receiver's orientation is correctly aligned.

► **MULTI-DIRECTIONAL ANTENNA**

No nulls or false peaks to complicate the locate

► **GREATER ACCURACY**

Verify the locate position using a micro-mapping display to mark distinctive poles in front of and behind the target

► **AUTOMATIC DEPTH**

Depth is automatically calculated and displayed when over the target



CATALOG NO.	DESCRIPTION
19243	NaviTrack Scout Locator

Accessories

CATALOG NO.	DESCRIPTION
16728	Remote Transmitter, 512-AAA

Replacement Parts

CATALOG NO.	DESCRIPTION
20248	Scout Carrying Case
12543	Marker Chips and Clip





*18 V Lithium ion battery available as separate accessory.

RIDGID® SEEKTECH® ST-33Q+ TRANSMITTER

DIRECT CONNECT ANY FREQUENCY FROM 10 HZ TO 93 KHZ

The RIDGID SeekTech ST-33Q+ Line Transmitter with Bluetooth is a powerful line transmitter for applying a signal to buried pipes and cables. It will direct connect using any frequency from 10 Hz to 93 kHz* with power up to 10 watts. The ST-33Q+ is flexible - using D-Cell alkaline batteries or 18 V rechargeable RIDGID batteries for minimal interruptions on the job. And, its Bluetooth feature allows you to finish complex locates faster by wirelessly changing the transmitted frequency from the SR-24 receiver from up to 183 m away.

► **MORE CURRENT**

Induce 8x more current than traditional transmitters allowing you to walk and trace further

► **POWER OPTIONS**

Runs on Lithium-Ion 18 V rechargeable battery, six D-cell batteries or an external 10-28 VDC power source

► **WIRELESS CONTROL**

Change transmitted frequency remotely from the SR-24, up to 183 m away

CATALOG NO.	DESCRIPTION
49343R	SeekTech ST-33Q+ Transmitter with Bluetooth®
20973	SeekTech 4" (100 mm) Inductive Signal Clamp
45433	Set of (2) 18 V 4.0 Ah Lithium Batteries and (1) 230 V Charger



* Devices sold in Europe are limited up to 93 kHz

RIDGID SEEKTECH ST-510 TRANSMITTER

ENERGIZE METALLIC LINES FOR TRACING WITH A LOCATOR

The RIDGID SeekTech ST-510 transmitter features 10 watts of fully variable power output. Its LCD display provides instant visual feedback on line resistance and current flow while audio feedback confirms a good circuit before beginning a trace.

► **VARIABLE POWER**

10 watts of fully variable power output

► **LCD DISPLAY**

Instant visual feedback on line resistance and current flow

► **AUDIO CONFIRMATION**

Confirm a good circuit before beginning a trace

CATALOG NO.	DESCRIPTION
21953	SeekTech ST-510 Transmitter (10 Watts)



RIDGID® SEEKTECH® ST-305 TRANSMITTER

TRANSMIT TWO FREQUENCIES SIMULTANEOUSLY

The SeekTech ST-305 Line Transmitter lets you energize metallic lines for tracing. Lightweight and compact, the ST-305 delivers up to 5 watts of power. Audio feedback confirms a good circuit before beginning a trace.

- ▶ **COMPACT POWER**
Lightweight transmitter delivers up to 5 watts of power
- ▶ **DUAL FREQUENCY**
Transmit two frequencies simultaneously
- ▶ **AUDIO CONFIRMATION**
Confirm a good circuit before beginning a trace

CATALOG NO.	DESCRIPTION
21948R	SeekTech ST-305 Transmitter (5 Watts)



RIDGID SEEKTECH INDUCTIVE SIGNAL CLAMP ACCESSORY

COMPATIBLE WITH ALL RIDGID TRANSMITTERS

The RIDGID SeekTech Inductive Signal Clamp lets you apply a signal to a cable or pipe when direct connection is not possible.

CATALOG NO.	DESCRIPTION
20973	SeekTech 4" (100 mm) Inductive Clamp



RIDGID BATTERY SONDE

MEETS FCC CLASS B AND EN 55022 CLASS B REQUIREMENTS

The RIDGID Remote Transmitter attaches to a drain cleaning cable or water jetter hose for in-line locating. It features a 512 Hz signal and flashing LED lights that indicate that the sonde is transmitting.

CATALOG NO.	DESCRIPTION
16728	Battery Sonde, 512 – AAA

Multiple adapters in different sizes available to fit on drain cleaning cables and hoses.



RIDGID® MR-10 MAGNETIC LOCATOR

QUICKLY LOCATE BURIED IRON OR STEEL OBJECTS

The RIDGID MR-10 Magnetic Locator quickly locates buried iron or steel objects like: valve/curb boxes, manhole covers, cast iron pipes, steel enclosures, well casings, reinforced septic tanks and survey pins. Its AutoNull feature blocks out nearby metallic interference like automobiles or chain link fences.

- ▶ **RUGGED DESIGN**
Includes carrying case and batteries.
- ▶ **AUTONULL**
Blocks out metallic interference.

CATALOG NO.	DESCRIPTION
53068	MR-10 Magnetic Locator with Case

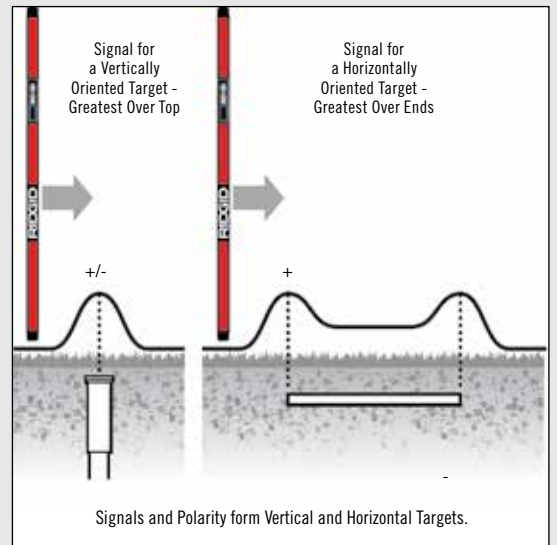
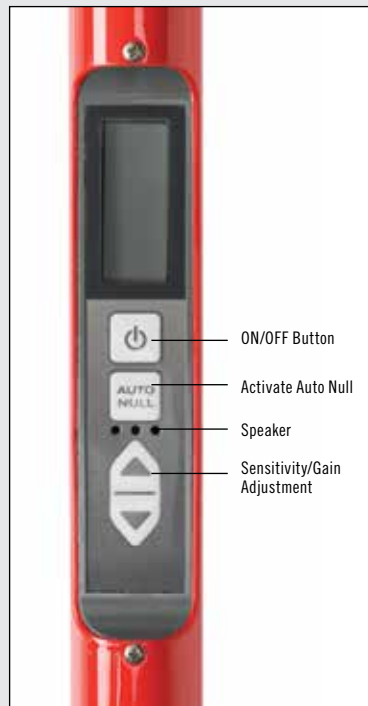

RIDGID® A-FRAME FAULT LOCATOR

LOCATES INSULATION FAULTS UP TO 2 MEGOHMS

The RIDGID A-Frame Fault Locator simplifies the location of ground faults in direct buried insulated wire. It's lightweight powder-coated aluminum frame is incredibly durable while the weatherproof membrane buttons stand up to everything Mother Nature dishes out.

► **FAULT FINDER**

Locates insulation faults up to 2 megohms

► **RUGGED CONSTRUCTION**

Durable powder-coated aluminum frame and weatherproof membrane buttons



CATALOG NO.	DESCRIPTION
56613	A-Frame Fault Locator (FR-30) and Receiver (FT-103)

Accessories

CATALOG NO.	DESCRIPTION
20973	SeekTech 4" (100 mm) Inductive Signal Clamp
30123	RIDGID SeekTech SR-60 Line Locator with Case
46393	RIDGID SR-24 Line Locator with Bluetooth® and GPS
21943	RIDGID SeekTech SR-20 Line Locator with Case

Replacement Parts

CATALOG NO.	DESCRIPTION
57753	Transmitter, FT-103 3-Watt
57758	A-Frame Receiver, FR-30 Fault Locator
57763	Ground Stake, FT-103
57768	Red and Black Test Leads, FT-103



TEST & MEASUREMENT

FOR ANY PROBLEM, THERE IS A SOLUTION!

Whether you need to trouble-shoot electrical problems, quickly pinpoint combustible gas leaks or accurately measure distances; RIDGID offers a wide range of reliable and durable Test & Measurement Tools that will help you getting the job done as efficient as possible!

KEY FEATURES

- FAST & ACCURATE MEASUREMENTS OF DISTANCES, HUMIDITY, SURFACE & AIR TEMPERATURES
- RELIABLE GAS LEAK DETECTION AND ELECTRICAL TROUBLE-SHOOTING
- DESIGNED TO THE HIGHEST QUALITY STANDARDS YET VERY EASY-TO-USE
- RIDGID TEST & MEASUREMENT DEVICES FEATURE LARGE BACKLIT LCD DISPLAYS DESIGNED TO BE EASILY READ BOTH INDOORS AND OUTDOORS
- ALL RIDGID TEST & MEASUREMENT TOOLS ARE SUPPLIED BY DEFAULT WITH THE NECESSARY ACCESSORIES, INCLUDING BATTERY AND CARRYING CASE. NO SURPRISES!



MICRO IR-200 INFRARED THERMOMETER

QUICK AND ACCURATE SURFACE TEMPERATURE READINGS

- ▶ **ULTRA-SHARP DUAL CLASS II LASERS**
Easily identify the surface area being measured
- ▶ **ACCURATE MEASUREMENTS**
30-to-1 distance-to-spot-ratio lets you take accurate measurements from further away
- ▶ **ADJUSTABLE EMISSIVITY**
Measure the temperature of virtually any surface
- ▶ **CUSTOM RANGE**
Audible and visual high and low alarms alert you to temperatures outside the range you set

CATALOG NO.	DESCRIPTION
36798	micro IR-200 Non-Contact Infrared Thermometer



MICRO CD-100 GAS DETECTOR

THE FAST AND EASY WAY TO IDENTIFY COMBUSTIBLE GASES

- ▶ **TRI-MODE DETECTION™**
Visual, audible or vibration alerts can be adjusted for your environment
- ▶ **ONE-TOUCH ADJUSTMENT**
Change sensitivity settings with the touch of a button
- ▶ **DETECT IN CONFINED SPACES**
40 cm flexible probe is perfect for hard-to-reach areas
- ▶ **IN-FIELD SERVICEABILITY**
Replace the sensor on the job for more up-time

CATALOG NO.	DESCRIPTION
36163	micro CD-100 Combustible Gas Detector



MICRO LM-400 ADVANCED LASER DISTANCE METER UP TO 100 M

QUICK DISTANCE READINGS AND ADVANCED CALCULATIONS SHARABLE BY SMARTPHONE OR TABLET

- ▶ **CLEAR VIEWING**
Large, backlit four-line display
- ▶ **INCLINATION ANGLE MEASUREMENT**
Get indirect measurements for hard-to-reach areas
- ▶ **BLUETOOTH® CONNECTION**
View, store and share data via smartphone or tablet
- ▶ **PHOTO OR SKETCH OVERLAY**
Transfer measurements onto a sketch or picture by using the free RIDGID Sketch App.

CATALOG NO.	DESCRIPTION
36813	micro LM-400 Laser Distance Meter w/BLE
36158	micro LM-100 Laser Distance Meter

Download the FREE
RIDGID VIEW App!



MICRO LM-100 LASER DISTANCE METER

- ▶ Ultra Sharp Class II Lasers clearly highlight the point being measured.
- ▶ Exceptional distance range allows accurate measurements up to 70 m.
- ▶ Adjustable units enable you to quickly read feet, inches or meters on the fly.
- ▶ Bright backlit display for use in poorly lit areas.



RIDGID® DM-100 DIGITAL MULTIMETER

WATER-RESISTANT & DROP-PROOF DIGITAL MULTIMETER

The RIDGID® micro DM-100 Digital Multimeter sets the new standard for troubleshooting most of the electrical problems! Featuring a double molded waterresistant (1m) IP67 housing, the micro DM-100 is also drop-proof and perfectly suitable for use in the harshest jobsite conditions.

The micro DM-100 is a True RMS and AutoRanging unit, providing the most accurate and fast measurements in all applications. It features 11 different electrical functions ranging from AC/DC Voltage & Current (1000 V) to Temperature measurements. The micro DM-100 is also rated for industrial use (CAT III-1000 V & IV-600 V) and features an Extra Large Backlit LCD display for easy and clear readings.

- ▶ IP 67 waterproof & drop-proof
- ▶ 11 FUNCTIONS IN ONE: Current AC/DC, Voltage AC/DC, Resistance, Capacitance, Frequency, Diode Test, Continuity Test, Duty Cycle and Temperature
- ▶ True RMS / AutoRanging
- ▶ Soft carrying case, double-molded test leads, Type K temperature probe and 9V battery included for free
- ▶ CAT III & IV 1000V/600V: Ideal for Industrial Use

CATALOG NO.	DESCRIPTION
37423	micro DM-100 Digital Multimeter



RIDGID® CM-100 DIGITAL CLAMP METER

10-IN-1 TRUE RMS CLAMP METER WITH MANY MULTIMETER FUNCTIONS

The micro CM-100 is a True RMS & AutoRanging Digital Clamp Meter with a large capacity and measuring range.

It can clamp around cables up to 30 mm O.D. and measure current up to 1000A AC/DC. The slim and double-molded design provides easy one-handed operation and can be conveniently used in confined cable compartments. Besides measuring AC/DC Current, the micro CM-100 can also be used as a Multimeter for 8 other functions and will provide clear and accurate readings on its large Backlit LCD.

- ▶ LARGE CAPACITY & MEASURING RANGE – Up to 100 A / 600 V.
- ▶ 10 FUNCTIONS IN ONE – Current AC/DC, Voltage AC/DC, Resistance, Capacitance, Frequency, Diode Test, Continuity Test, Temperature.
- ▶ True RMS / AutoRanging
- ▶ Soft carrying case, insulated Test Leads, Type K temperature probe and 9V battery included for free.

CATALOG NO.	DESCRIPTION
37428	micro CM-100 Digital Clamp Meter



RIDGID® HM-100 TEMPERATURE HUMIDITY METER

FOR ACCURATE MEASUREMENTS OF AIR HUMIDITY AND TEMPERATURE

The micro HM-100 Temperature Humidity Meter is a professional and easy to use device for accurately measuring air humidity and temperature. Both measured values (%RH and °C or °F) are instantly and simultaneously displayed on the Dual Backlit LCD. Assessing Indoor Air Quality, Air Conditioning systems, Ventilation and Storage conditions is now only a matter of 'push on the button'.

- ▶ Easy & accurate measurements of air temperature & humidity
- ▶ Dew point and wet-bulb calculation

CATALOG NO.	DESCRIPTION
37438	micro HM-100 Temperature Humidity Meter



RIDGID® CL-100 SELF-LEVELING CROSS-LINE LASER

TRIPOD AND LASER ENHANCING GLASSES INCLUDED FOR FREE

The RIDGID® micro CL-100 offers an amazing value for a cross line laser. With a 'single knob operation' the micro CL-100 is very easy to use and helps you to get your leveling or alignment job done at the blink of an eye!

- ▶ Single knob operation, very easy to use.
- ▶ Leveling and alignment jobs done at the blink of an eye.
- ▶ Instant projection of super-bright vertical and horizontal lines.
- ▶ Laser type: Class 2, 630-670 nm.
- ▶ Millimeter accuracy: 0,6 mm / 1 m.
- ▶ Extended interior range of 30 meters.

CATALOG NO.	DESCRIPTION
38758	micro CL-100 Digital Clamp Meter

INNOVATION TECHNOLOGY TRADITION CONFIDENCE RIDGID

Get Exclusive Product Updates and
Promotions by Signing up to the Newsletter:

RIDGID.EU/SIGNUP

Follow US



RIDGID[®]

Ridge Tool Europe N.V.
Ondernemerslaan 5428
B-3800 Sint-Truiden
Belgium

Tel.: +32 (0)11 598 620
RIDGID.eu@emerson.com
RIDGID.com

EMERSON[™]