

**RIDGID**

# PRESSING

PRODUCT CATALOG

**RIDGID**

©2019, RIDGID, Inc. The Emerson logo and RIDGID logo are registered trademarks of Emerson Electric Co. or RIDGID, Inc. in the U.S. and other countries. All other trademarks belong to their respective holders. 999-997-618.10 2/2019

  
**EMERSON**



# BUILT FOR THOSE WHO KNOW™

When you work in the skilled trades, you leave your mark on every job you touch. Your reputation is built over time. Day by day, job by job.

When it's your name on the line, make sure our name is on your tool. For nearly 100 years, we've built our legacy the same way you have — one job at a time. We make tools that stand up to the toughest challenges and last long enough for you to pass them down to the next generation. We deliver a better way to work.

It's more than our promise. We guarantee it.



## TABLE OF CONTENTS

	10	RP 340 PRESS TOOL
	12	RP 240 PRESS TOOL
	13	RP 241 PRESS TOOL
	14	PEX-ONE/MANUAL PRESS TOOLS
	16	STANDARD JAWS
	17	COMPACT JAWS
	18	TIGHT ACCESS PRESS RINGS
	19	STANDARD XL-C™ AND PRESS RINGS
	20	PRESS BOOSTER
	22	MEGAPRESS® JAWS AND RINGS
	23	MEGAPRESS PRESS-IN BRANCH CONNECTOR
	24	SOIL PIPE CUTTER
	25	RIDGID LINK APP

# PRESS CONFIDENTLY. PRESS WITH THE BEST.

RIDGID® press tools save you time and money by delivering reliable performance press after press. Every generation of press tools works harder — and smarter — than the last. We are constantly working to reduce in-use tool weight while increasing overall performance. That's why we are the #1 press tool manufacturer since 1999.  
**RIDGID: BUILT FOR THOSE WHO KNOW.™**



PRESS CONNECTIONS ON A "WET" SYSTEM.



LOWER TOTAL INSTALLATION COST.



WATERTIGHT PRESS CONNECTIONS IN 5 SECONDS OR LESS.



REDUCES VITAL EQUIPMENT SHUTDOWNS.



NO OPEN FLAMES. NO BURN PERMITS. NO ONSITE FIRE WATCH.

## #1 IN NORTH AMERICA

RIDGID® revolutionized the North American Market by introducing press technology in 1999. Since that time, RIDGID has become the most recognizable and trusted brand for press tools. To this day, the RP 340 stands as the number #1 selling press tool in North America.

## TESTED UNDER PRESSURE.

RIDGID tools are tested under the toughest conditions to ensure that each tool will work properly in any environment. RIDGID designers, testers and engineers work closely with Viega®, the global leader in press fittings, to deliver secure connections with every press. RIDGID press tools stand up to every test in the field because they've already passed the hardest ones in the lab.

## CHANGING THE GAME.

RIDGID® is the top press tool in North America due to constant innovation. It introduced the first lithium ion battery for pressing, the first soil pipe cutter actuated by a press tool, the first tools for pressing iron pipe and the first power tool specifically designed to press PEX copper ring systems. Most recently, RIDGID introduced its Press Booster for use with Viega® MegaPress® XL fittings, the first tool able to press steel pipe 2½" to 4".

## SMALLER. FASTER. SMARTER.

Today, every generation of RIDGID press tools works harder and smarter than the last. The RP 340, for example, is nearly half the weight of its original predecessor. The RP 240 and RP 241 are more than two pounds lighter than the RP 100B, the original compact press tool. Current models also come equipped with Bluetooth® compatibility, so the tools can interface with RIDGID Link, an app that tracks tool performance, tells you where the tool was last seen and delivers helpful service reminders among other features. RIDGID Link easily interfaces with both iOS and Android phones and tablets.

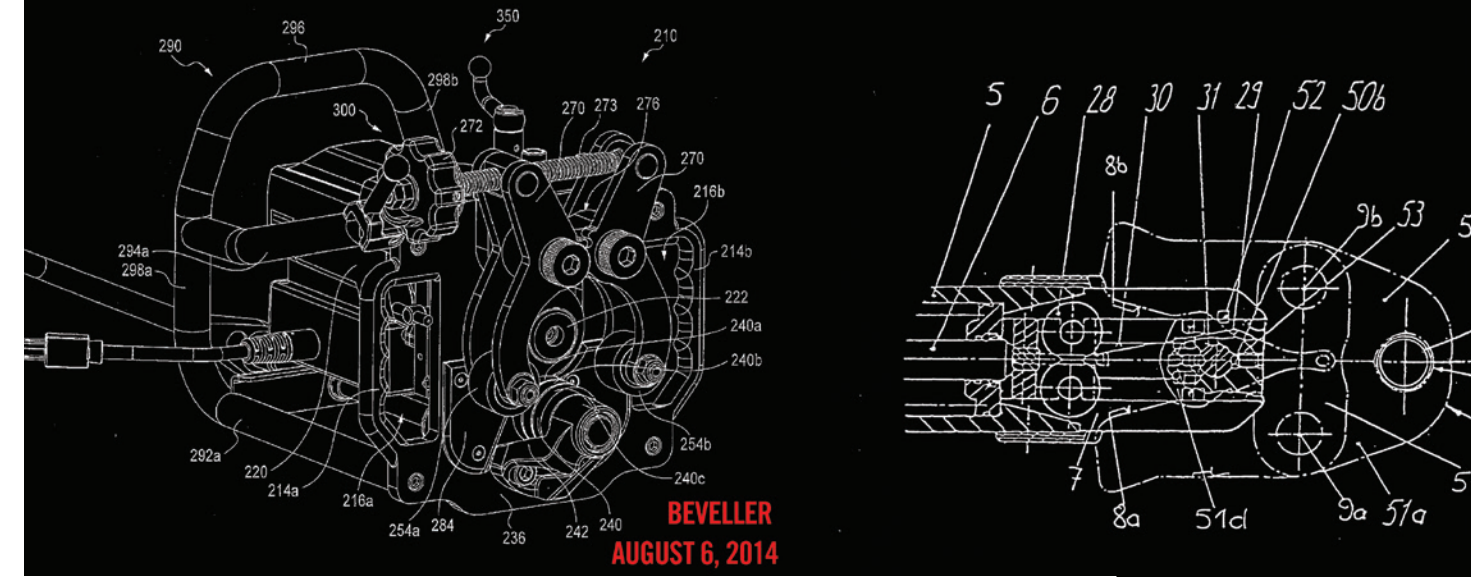

**BEVELLER  
AUGUST 6, 2014**

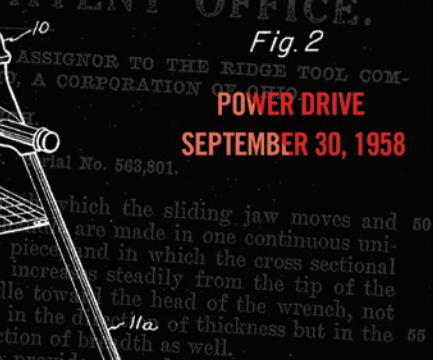
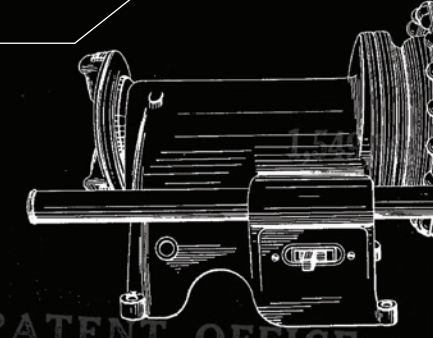
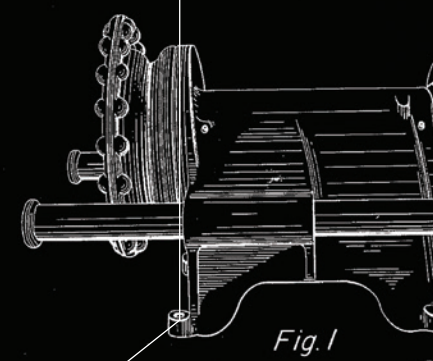
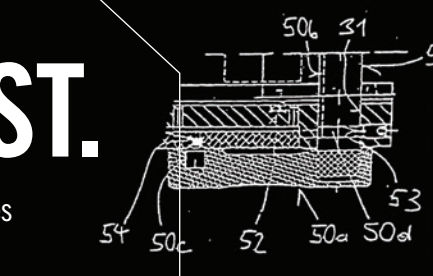
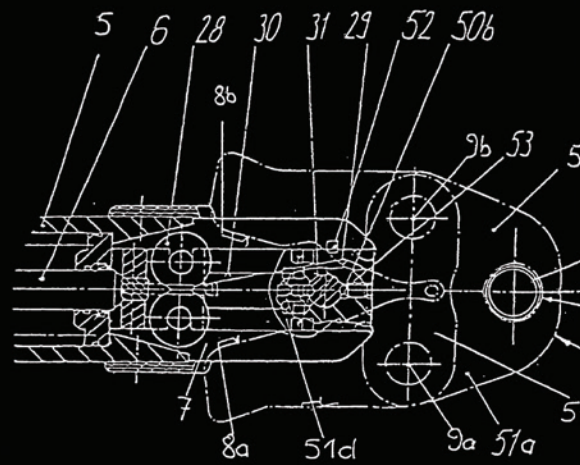

**POWER DRIVE  
SEPTEMBER 30, 1958**



# PRESS TOOLS

**#1 IN PRESS TOOLS SINCE 1999.**

RIDGID® press tools are unsurpassed in making quick and reliable connections on copper, steel, stainless steel and PEX tubing. No open flames. No mess. Just secure connections in less than five seconds – wet or dry.

- KEY FEATURES**
- FLAMELESS SYSTEM
  - FASTER CONNECTIONS
  - ALL-DAY POWER



# THE BEST NEVER REST.

With more than 100 patents already secured and more on the way, RIDGID® continues to deliver a better way to work. Every press tool, jaw or ring is purpose-built based on feedback from the field. This history of field-driven innovation – coupled with the industry's best lifetime warranty – makes RIDGID the most trusted brand for trade professionals all around the world.



**PIPE WRENCH MAY 26, 1922**

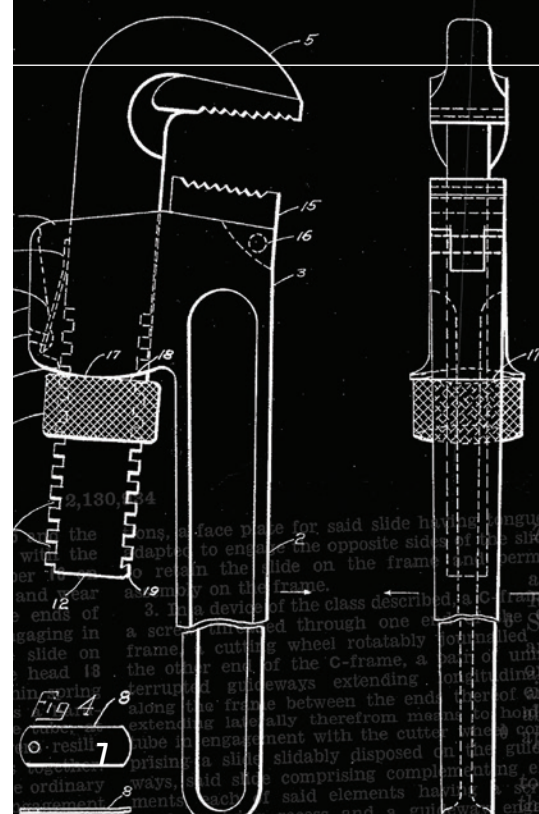

Patented Aug. 11, 1925.

UNITED STATES PATENT OFFICE.  
WILLIAM O. THEWES OF RIDGEVILLE, OHIO, ASSIGNOR TO THE RIDGE TOOL COMPANY, OF RIDGEVILLE, OHIO, A CORPORATION OF OHIO.

Fig. 2

Fig. 1

### APPLICATION CHART

	COMPACT PRESS TOOLS	STANDARD PRESS TOOL	PEX TOOL	
<b>WEIGHT (TOOL AND BATTERY):</b>	5.2 lbs.	5.2 lbs.	8.3 lbs.	5.9 Lbs.
<b>BATTERY:</b>	12V Advanced Lithium 2.5 Battery	12V Advanced Lithium 2.5 Battery	18V Advanced Lithium 2 Battery	12V Advanced Lithium 2.5 Battery
<b>VEIGA PROGRESS® COMPATIBLE:</b>	½" - 1¼"	½" - 1¼"	½" - 4"	N/A
<b>VEIGA PUREFLOW™ COMPATIBLE:</b>	¾" - 1½"	¾" - 1½"	½" - 2"	N/A
<b>ASTM F 1807 COMPATIBLE:</b>	½" - 1¼"	½" - 1¼"	N/A	½" - 1"
<b>VEIGA MEGAPRESS® COMPATIBLE:</b>	½" - ¾"	½" - ¾"	½" - 4"	N/A



# RP 340 PRESS TOOL

**CAPACITY: 1/2" TO 4" (COPPER, STEEL AND STAINLESS STEEL); 1/2" TO 2" (PEX)**

- ▶ **WEIGHT**  
Tool Only – 7.3 lbs.  
Tool with Battery – 8.3 lbs.  
Tool with Battery and 1/2" Jaws – 12.3 lbs.
- ▶ **HYDRAULIC RAM OUTPUT**  
7,200 lbs. (32kN)
- ▶ **CYCLE TIME**  
~4 Seconds
- ▶ **SERVICE INTERVAL**  
42,000 Cycles
- ▶ **POWER**  
18V Advanced Lithium Battery  
400+ Crimps Per Charge using Advanced Lithium 4 Battery  
Optional AC Power Adapter
- ▶ **OPERATING TEMPERATURE RANGE**  
15°F to 122°F (-10°C to 50°C)
- ▶ **LIGHTING**  
Large LED Light
- ▶ **180° BARREL/JAW SWIVEL**
- ▶ **COMPATIBILITY**  
RIDGID® Standard Series Press Jaws and Attachments



- **WORLD'S #1 PRESS TOOL**  
Industry leader in press tools.
- **ALL-DAY POWER**  
18V Advanced Lithium 4 battery delivers 400 presses per charge.
- **MULTI-FUNCTIONAL**  
World's most versatile press tool.

*See pages 16, 18, 19, 22, 23 and 24 for compatible jaws, rings and accessories.*

## RP 340 Battery Press Tool

CATALOG NO.	DESCRIPTION	WEIGHT LB.
43358	RP 340 Battery Press Tool Kit with 1/2" - 2" ProPress® Jaws	51.0
43353	RP 340 Battery Press Tool Kit with 1/2" - 1" ProPress Jaws	31.0
43348	RP 340 Battery Press Tool Kit without Jaws	19.0
44483	RP 340 Press Tool Only	7.3

All RP 340 battery kits include the RP 340, 2 18V Advanced Lithium 2 batteries, battery charger and carrying case.

## RP 340 Corded Press Tool

CATALOG NO.	DESCRIPTION	WEIGHT LB.
43373	RP 340 Corded Press Tool Kit with 1/2" - 2" ProPress Jaws	48.0
43368	RP 340 Corded Press Tool Kit with 1/2" - 1" ProPress Jaws	28.0
43363	RP 340 Corded Press Tool Kit without Jaws	16.0
44483	RP 340 Press Tool Only	7.3

All RP 340 Corded tool kits include the RP 340 Corded Tool, power adapter, and carrying case.

## Accessories

CATALOG NO.	DESCRIPTION	WEIGHT LB.
43378	RP 340 Press Tool Carrying Case	8.0
44798	Charger Replacement Cord (N. America)	0.3
44468	120V AC Power Adapter	1.0



RP 340 Battery Tool with ProPress Jaws



RP 340 Corded Tool with ProPress Jaws



18V Advanced Lithium Battery

## RP 240 PRESS TOOL



**CAPACITY:** 1/2" TO 1 1/4" (COPPER AND STAINLESS STEEL); 3/8" TO 1 1/2" (PEX); 1/2" TO 3/4" (STEEL)

- ▶ **WEIGHT**  
Tool Only – 4.8 lbs.  
Tool with Battery – 5.3 lbs.  
Tool with Battery and 1/2" Jaws – 7.4 lbs.
- ▶ **LENGTH:** 13"
- ▶ **HEIGHT:** 9.5"
- ▶ **HYDRAULIC RAM OUTPUT**  
5,400 lbs. (24kN)
- ▶ **CYCLE TIME**  
~5 Seconds
- ▶ **SERVICE INTERVAL**  
32,000 Cycles
- ▶ **BATTERY**  
12V Advanced Lithium 2.5
- ▶ **CHARGE**  
140+ Crimps Per Charge
- ▶ **OPERATING TEMPERATURE RANGE**  
15°F to 140°F (-10°C to 60°C)
- ▶ **LIGHTING**  
Large LED Light
- ▶ **180° BARREL/JAW SWIVEL**
- ▶ **COMPATIBILITY**  
RIDGID® Standard Series Press Jaws and Attachments

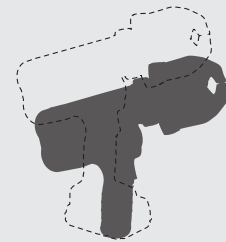

12V Advanced Lithium 2.5 Battery



- ▶ **COMPACT POWER**  
15% smaller and 10% lighter than its predecessor.
- ▶ **BETTER BALANCE**  
Ergonomic, pistol-grip design for all-day comfort.
- ▶ **TOTALLY CONNECTED**  
Bluetooth® syncs tool to RIDGID Link app.  

See pages 17, 18 and 22 for compatible jaws and rings.

CATALOG NO.	DESCRIPTION	WEIGHT LB.
57398	RP 240 Kit with 1/2" - 1 1/4" ProPress® Jaws	24.5
57403	RP 240 Kit with 1/2" - 1" ProPress Jaws	22.5
57408	RP 240 Kit with 1/2", 3/4" and 1" PureFlow™ Jaws	22.5
57413	RP 240 Kit without Jaws	14.5
57418	RP 240 Press Tool Only	6.5

All RP 240 Kits include the RP 240, 2 12V Lithium-Ion batteries, battery charger, and carrying case. (Excluding Press Tool Only Kit).

### Accessories

CATALOG NO.	DESCRIPTION	WEIGHT LB.
55183	12V Battery	0.5
55193	12V Battery Charger	1.5
57393	Carrying Case RP 241	1.0

## RP 241 PRESS TOOL



**CAPACITY:** 1/2" TO 1 1/4" (COPPER AND STAINLESS STEEL); 3/8" TO 1 1/2" (PEX); 1/2" TO 3/4" (STEEL)

- ▶ **WEIGHT**  
Tool Only – 4.8 lbs.  
Tool with Battery – 5.3 lbs.  
Tool with Battery and 1/2" Jaws – 7.4 lbs.
- ▶ **LENGTH:** 15.8"
- ▶ **HEIGHT:** 4.25"
- ▶ **HYDRAULIC RAM OUTPUT**  
5,400 lbs. (24kN)
- ▶ **CYCLE TIME**  
~5 Seconds
- ▶ **SERVICE INTERVAL**  
32,000 Cycles
- ▶ **BATTERY**  
12V Advanced Lithium 2.5
- ▶ **CHARGE**  
140+ Crimps Per Charge
- ▶ **OPERATING TEMPERATURE RANGE**  
15°F to 140°F (-10°C to 60°C)
- ▶ **LIGHTING**  
Large LED Light
- ▶ **180° BARREL/JAW SWIVEL**
- ▶ **COMPATIBILITY**  
RIDGID® Standard Series Press Jaws and Attachments

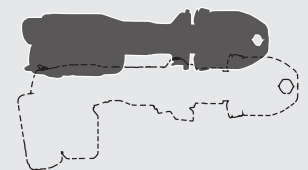

12V Advanced Lithium 2.5 Battery



- ▶ **COMPACT POWER**  
25% smaller and 10% lighter than its predecessor.
- ▶ **TOTAL VERSATILITY**  
Ergonomic, inline design presses in tight spaces.
- ▶ **TRACK CRIMPS**  
Bluetooth® syncs tool to RIDGID Link app.  

See pages 17, 18 and 22 for compatible jaws and rings.

CATALOG NO.	DESCRIPTION	WEIGHT LB.
57363	RP 241 Kit with 1/2" - 1 1/4" ProPress® Jaws	24.5
57373	RP 241 Kit with 1/2" - 1" ProPress Jaws	22.5
57378	RP 241 Kit with 1/2", 3/4" and 1" PureFlow™ Jaws	22.5
57383	RP 241 Kit without Jaws	14.5
57388	RP 241 Press Tool Only	6.5

All RP 241 Kits include the RP 241, 2 12V Lithium-Ion batteries, battery charger, and carrying case. (Excluding Press Tool Only Kit).

### Accessories

CATALOG NO.	DESCRIPTION	WEIGHT LB.
55183	12V Battery	0.5
55193	12V Battery Charger	1.5
57393	Carrying Case RP 241	1.0

# PEX-ONE™ BATTERY OPERATED PEX TOOL

**CAPACITY: ½" TO 1" (ASTM F 1807)**

- ▶ **WEIGHT**  
Tool Only – 5 lbs.  
Tool with Battery and Dies – 5.9 lbs.
- ▶ **LENGTH:** 16.5"
- ▶ **CYCLE TIME**  
~5 Seconds
- ▶ **SERVICE INTERVAL**  
20,000 Cycles
- ▶ **BATTERY**  
12V Advanced Lithium 2.5
- ▶ **CHARGE**  
150+ Crimps Per Charge
- ▶ **LIGHTING**  
Large LED Light



- ▶ **ONE-HANDED OPERATION**  
Free your other hand to guide the connection.
- ▶ **ACCESS TIGHT SPACES**  
Lightweight, inline design for hard-to-reach areas.
- ▶ **POWER THROUGH**  
More than 150 crimps on a single charge.

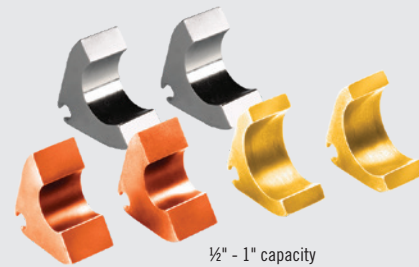

CATALOG NO.	DESCRIPTION	WEIGHT LB.
54253	PEX-One Kit with ½" - 1" ASTM F1807 Dies	10.0
56638	PEX-One Tool Only	5.0

**Dies**

CATALOG NO.	DESCRIPTION	WEIGHT LB.
56568	½" - 1" ASTM F1807 Dies Set	1.0
56573	½" ASTM F1807 Die	0.4
56578	¾" ASTM F1807 Die	0.3
56583	1" ASTM F1807 Die	0.3

**Accessories**

CATALOG NO.	DESCRIPTION	WEIGHT LB.
55183	12V Li-Ion Battery	0.5
55193	12V Battery Charger	1.5
56608	RIDGID® Bag, 20", Soft-Sided	3.4

# MANUAL PRESS TOOLS

**CAPACITY: ½" TO 1"**

- ▶ Available sizes: ½", ¾", 1" and ½" and ¾" combo tool
- ▶ Easily adjustable lock screw for tool calibration
- ▶ All tools come standard with a go/no-go gauge

ASTM F 1807 Traditional PEX Crimp Tool



ASTM F 1807 Close Quarters PEX Crimp Tool

CATALOG NO.	DESCRIPTION	WEIGHT LB.
23448	½" PEX Crimp Tool	2.9
23458	¾" PEX Crimp Tool	2.9
23463	1" PEX Crimp Tool	3.0
23468	½" and ¾" PEX Combo Tool	3.5
43853	½" PEX Close Quarters Crimp Tool	2.1
43858	¾" PEX Close Quarters Crimp Tool	2.3

**Accessories**

CATALOG NO.	DESCRIPTION	WEIGHT LB.
23473	¾"- ¼" ASTM F 1807 Gauge	1.0
23478	1" ASTM F 1807 Gauge	1.0
29583	¾" - 1" ASTM F 1807 Gauge	1.0

- ▶ **LESS FORCE**  
33% less force required compared to traditional PEX crimp tools.
- ▶ **LIGHTER WEIGHT**  
Glass-filled polycarbonate handles make the tool 20% lighter than traditional PEX crimp tools.
- ▶ **ALL DAY COMFORT**  
E<sup>3</sup>® (Expert Engineered Ergonomics) handles provide increased feel and usability.

# STANDARD JAWS FOR VIEGA® PROPRESS® OR PUREFLOW™ - ½" TO 2"

FOR USE WITH RP 340, RP 330, 320-E, CT 400



## Jaws For ProPress (Copper and Stainless)

CATALOG NO.	DESCRIPTION	WEIGHT LB.
76652	½" Jaw for ProPress	4.0
76657	¾" Jaw for ProPress	4.3
76662	1" Jaw for ProPress	4.5
76667	1¼" Jaw for ProPress	4.8
76672	1½" Jaw for ProPress	6.5
76677	2" Jaw for ProPress	10.0

## Jaws For PureFlow (PEX)

CATALOG NO.	DESCRIPTION	WEIGHT LB.
22653	½" Jaw for PureFlow	4.0
22658	¾" Jaw for PureFlow	4.3
22663	¾" Jaw for PureFlow	4.5
22668	1" Jaw for PureFlow	4.5
22673	1¼" Jaw for PureFlow	4.8
22678	1½" Jaw for PureFlow	6.5
35343	2" Jaw for PureFlow	10.0



# COMPACT JAWS FOR VIEGA® PROPRESS®, PUREFLOW™ OR ASTM F 1807 - ½" TO 1½"

FOR USE WITH RP 241, RP 240, RP 210-B, RP 200-B, RP 100-B



## Jaws For ProPress (Copper and Stainless)

CATALOG NO.	DESCRIPTION	WEIGHT LB.
16958	½" Jaw for ProPress	2.5
16963	¾" Jaw for ProPress	2.5
16978	1" Jaw for ProPress	2.5
31228	1¼" Jaw for ProPress	2.5

## Jaws For PureFlow (PEX)

CATALOG NO.	DESCRIPTION	WEIGHT LB.
17003	¾" Jaw for PureFlow	2.5
17008	½" Jaw for PureFlow	2.5
19813	¾" Jaw for PureFlow	2.5
17013	¾" Jaw for PureFlow	2.5
17018	1" Jaw for PureFlow	2.5
22683	1¼" Jaw for PureFlow	2.5
22688	1½" Jaw for PureFlow	2.5

## Jaws For ASTM F 1807 (PEX)

CATALOG NO.	DESCRIPTION	WEIGHT LB.
22958	½" Jaw for ASTM F 1807	2.5
22968	¾" Jaw for ASTM F 1807	2.5
22973	1" Jaw for ASTM F 1807	2.5
22978	1¼" Jaw for ASTM F 1807	2.5



## TIGHT ACCESS PRESS RINGS - 1/2" TO 2"

FOR VIEGA® PROGRESS® COPPER AND STAINLESS FITTINGS

- V1 and V2 Kits are designed for RIDGID® Standard Press Tools.
- C1 Compact Kits are designed for RIDGID Compact Press Tools.

### Kits

CATALOG NO.	MODEL NO.	DESCRIPTION	WEIGHT LB.
27423	V1	V1 Kit, 1/2", 3/4", 1", 1 1/4" Ring	10.8
27428	V2	V2 Kit, 1 1/2", 2" Ring	13.6
28043	C1	C1 Kit, 1/2", 3/4", 1", 1 1/4" Ring	8.1
28048	V1/C1	V1/C1 Combo Kit, 1/2", 3/4", 1", 1 1/4" Ring	12.9

### PureFlow Jaws (PEX)

CATALOG NO.	MODEL NO.	DESCRIPTION	WEIGHT LB.
27998	V1/C1	1/2" Press Ring	0.5
28003	V1/C1	3/4" Press Ring	0.8
28008	V1/C1	1" Press Ring	1.0
28013	V1/C1	1 1/4" Press Ring	1.0
28018	V2	1 1/2" Press Ring	1.5
28023	V2	2" Press Ring	2.0

### Actuators

CATALOG NO.	MODEL NO.	DESCRIPTION	WEIGHT LB.
28033	V1	V1 Actuator for 1/2" - 1 1/4"	4.9
21878	V2	V2 Actuator for 1 1/2" - 2"	4.8
26163	C1	C1 Actuator for 1/2" - 1 1/4"	2.1

### Accessories

CATALOG NO.	MODEL NO.	DESCRIPTION	WEIGHT LB.
28028	V1/C1	Carrying Case #1 for 1/2" - 1 1/4"	3.0
28038	V2	Carrying Case #2 for 1 1/2" - 2"	3.0



## STANDARD RINGS - 2 1/2" TO 4"

FOR VIEGA® PROGRESS® XL-C™ COPPER FITTINGS AND XL-S STAINLESS FITTINGS

FOR USE WITH RP 340, RP 330, RP 320, CT 400



### SAVE TIME

Connect 2 1/2" to 4" copper and stainless in 5 seconds.

### ALL THE RIGHT ANGLES

Ball-tip V2 actuator swivels 180° for use in tight spaces.



180° swivel improves access to tight spaces.

CATALOG NO.	MODEL NO.	DESCRIPTION	WEIGHT LB.
20483	XL-C	2 1/2" - 4" Rings, Actuator and Case	40.3
20543	XL-C	2 1/2" Press Ring	6.0
20548	XL-C	3" Press Ring	9.8
20553	XL-C	4" Press Ring	11.8
21878	V2	V2 Press Ring Actuator	7.8
21103	XL-C	XL-C Carrying Case Only	7.8

# PRESS BOOSTER

FOR USE WITH VIEGA®  
MEGAPRESS XL FITTINGS

PATENTED 180° SWIVEL  
FOR GREATER ACCESS



AUTOMATIC LOCK  
KEEPS ACTUATOR  
IN PLACE UNTIL THE  
PRESS IS COMPLETE

INCREASES OUTPUT  
OF THE RP 340  
OR RP 330

## PRESS BOOSTER

FOR USE WITH VIEGA® MEGAPRESS XL FITTINGS

CAPACITY: 2 1/2" TO 4" STEEL

**GO BIGGER**

The only tool on the market that presses steel pipe up to 4".

**CONNECT FASTER**

Flameless system connects pipe in less than 25 seconds.

**Kits**

CATALOG NO.	DESCRIPTION	WEIGHT LB.
60638	Press Booster Kit with 2 1/2" - 4" MegaPress XL	52.5

For use with RIDGID® 32kN Press Tools with Press Booster (RP 340, RP 330).

CATALOG NO.	DESCRIPTION	WEIGHT LB.
60643	2 1/2" Ring for MegaPress XL	5.9
60648	3" Ring for MegaPress XL	7.1
60653	4" Ring for MegaPress XL	9.9
60658	Press Booster For MegaPress XL	21.6
60663	Press Booster Carrying Case	6.3



**NEW**

# STANDARD JAWS AND RINGS FOR VIEGA® MEGAPRESS - 1/2" TO 2"

FOR USE WITH RP 340, RP 330, 320-E, CT 400

- ▶ Save time and cost by press connecting steel pipe
- ▶ Flameless system eliminates the need for hot work permits
- ▶ Jointly developed and tested with Viega

**Kits**

CATALOG NO.	DESCRIPTION	WEIGHT LB.
48553	1/2" - 2" MegaPress Kit	48.5
48558	1/2" - 1" MegaPress Kit	23.1



**Jaws, Rings and Actuators**

CATALOG NO.	DESCRIPTION	WEIGHT LB.	INCLUDED IN	
			48553	48558
37958	1/2" Jaw for MegaPress	4.9	✓	✓
37963	3/4" Jaw for MegaPress	5.2	✓	✓
37968	1" Jaw for MegaPress	6.8	✓	✓
21878	V2 Ring Actuator	6.7	✓	—
37973	1 1/4" Ring for MegaPress	6.0	✓	—
37978	1 1/2" Ring for MegaPress	6.5	✓	—
37983	2" Ring for MegaPress	6.0	✓	—

**Accessories**

CATALOG NO.	DESCRIPTION	WEIGHT LB.	INCLUDED IN	
			48553	48558
37993	1/2" - 1" MegaPress Prep Tool	1.8	—	—
37988	1 1/4" - 2" MegaPress Prep Tool	2.5	—	—
38008	Abrasive Strips (Box of 10) 1/2" - 1"	0.3	—	—
38003	Abrasive Strips (Box of 10) 1 1/4" - 2"	0.3	—	—
48563	MegaPress Carrying Case	6.4	✓	✓



# COMPACT JAWS FOR MEGAPRESS - 1/2" TO 3/4"

FOR USE WITH RP 241, RP 240, RP 210-B, RP 200-B, RP 100-B

CATALOG NO.	DESCRIPTION	WEIGHT LB.
48433	1/2" Jaw for MegaPress	3.0
48438	3/4" Jaw for MegaPress	3.2

# MEGAPRESS PRESS-IN BRANCH CONNECTOR TOOL KIT

QUICKLY MAKE 3/4" BRANCHES OFF 1 1/2" TO 6" PIPE

- ▶ Flameless system for use with water, compressed air, select industrial gas and low-pressure steam systems
- ▶ Saves time and eliminates the need for hot work permits
- ▶ Compatible with all RIDGID® standard press tools (RP 340, RP 330, RP 320, CT-400)
- ▶ Includes: drill guide, arbor (works with standard handheld drill), expander, fitting position guides and vac adapters



CATALOG NO.	DESCRIPTION	WEIGHT LB.
50953	MegaPress Press-In Branch Connector	15.8

**Kit Standard Equipment**

CATALOG NO.	DESCRIPTION	WEIGHT LB.
50958	Drill Guide	6.5
31743	Vacuum Adapters	1.0
50963	Expander	1.5
50968	Arbor Shaft Assembly	1.4
62008	Fitting Positioning Guides	4.4
62013	MegaPress Press-In Branch Connector Carrying Case	2.0



# PRESS SNAP SOIL PIPE CUTTER

**CAPACITY: CUTS 1½" TO 4" NO HUB  
 AND SERVICE WEIGHT SOIL PIPE**

- ▶ Compatible with all RIDGID® 32kN press tools
- ▶ Standard Kit: Press Snap cutter, case and operator's manual



- EXPANDED CAPABILITIES**  
 Attaches to RIDGID 32kN press tools to cut cast iron soil pipe.
- NO SCORING**  
 Eliminates the need to score the pipe.
- ACCESS IS A SNAP**  
 No lengthy lever arms like traditional soil pipe cutters.

Press Snap Soil Pipe Cutter

CATALOG NO.	DESCRIPTION	WEIGHT LB.
34403	Press Snap Soil Pipe Cutter Kit	12.0
34678	Press Snap Soil Pipe Cutter Case	3.4

# RIDGID LINK. DOWNLOAD THE APP AND GET CONNECTED.

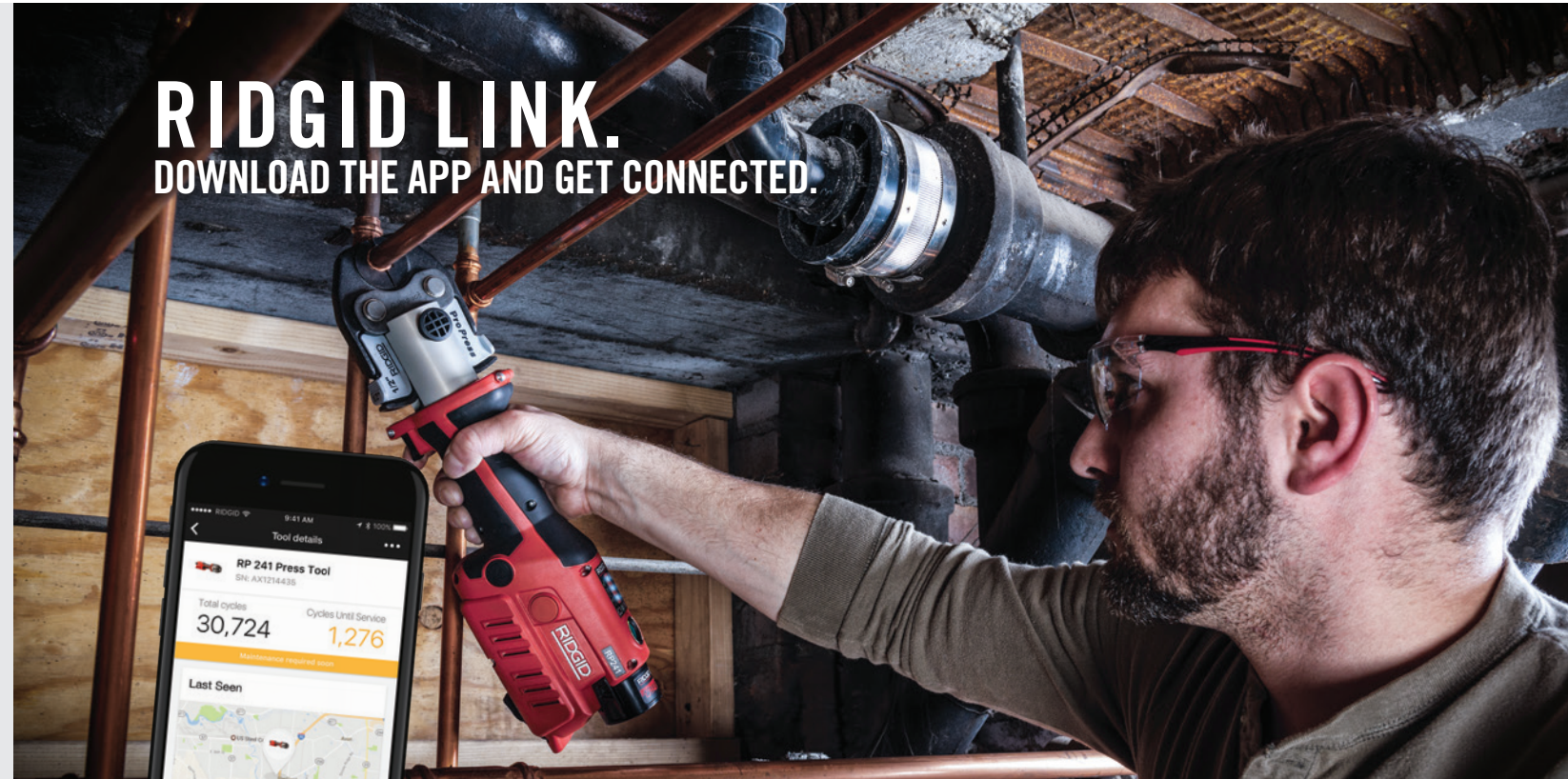

**SMARTER TOOLS WITH THE RIDGID LINK APP.**  
 Track tool data and maximize jobsite performance.



### COUNT

- Track tool usage with smart, cycle counter

### SERVICE

- Know how many crimps until service
- Use location to find a RIDGID® service center near you

### BATTERY

- App shows real-time battery life

### LOCATE

- See the location of where your RIDGID Link enabled tool was last seen

### SUPPORT

- Easily find operator's manuals, videos and more

### HOW TO GET STARTED:

1. Download the RIDGID Link app from Apple Store or Google Play.
2. Open the app and sign in using your RIDGID.com credentials or create new account.
3. Follow on-screen instructions to register your tool.



Contact Information: 888.743.4333 | RIDGID.com