

# SeekTech

## *SR-24* & *ST-330+*



Connecting with  Bluetooth<sup>®</sup>

# Table of Contents

## System Overview

Description .....	3
Bluetooth Specifications .....	3
Range.....	4

## Bluetooth Connection

Syncing the Devices .....	4
Disconnecting the Devices .....	5
Powering the Transmitter .....	6
Transmitter Control Screen .....	6

## System Overview

This document covers the basics of connecting the devices and controlling the transmitter from the receiver. Refer to the operator's manuals for the RIDGID SeekTech SR-24 and RIDGID SeekTech ST-33Q+ for more information on each product's individual specifications and operation.

## Description

The RIDGID SeekTech SR-24 receiver and RIDGID SeekTech ST-33Q+ transmitter are equipped with Bluetooth® which allows the units to communicate with one another during operation. With Bluetooth enabled on both units, the SR-24 can be used to remotely monitor the transmitter's screen and control its operation during a locate, eliminating the need to walk back and forth to the transmitter to change settings.

Bluetooth Specifications	
Type	Class 1
Profile	RFCOMM
Transmit power	19 dBm
Receiver sensitivity	-92 dBm
Typical maximum operating range*	100 m – 200 m (328 ft – 656 ft)
*Effective distance may vary	



## Range



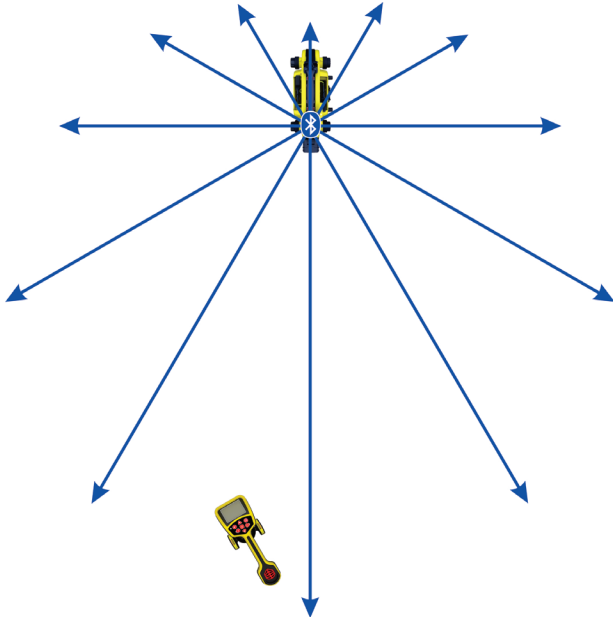





The ST-33Q+ and SR-24 work best when kept within 200 m [656 ft] of each other while connected by Bluetooth. The quality of the connection between devices may be affected by a number of factors including distance between devices and objects in the path between devices. For the best quality connection, maintain a clear line of sight between devices and set the transmitter so its battery faces the receiver. Objects blocking the line of sight between the transmitter and the receiver may significantly reduce the quality of their connection.



## Bluetooth Connection

### Connecting the Devices

To connect the devices, follow these steps:

1. Power on the receiver and press the Menu key .
2. Press the Down Arrow key  to scroll through the frequencies list. Highlight the Bluetooth icon  and press the Select key .
3. Press the Select key  when the search icon  appears.
4. Press the Down Arrow key  to highlight the transmitter you want to connect to. Press the Select key .

You can identify your transmitter by its name and the last four digits of its serial number. The transmitter does not need to be powered on to be discoverable.

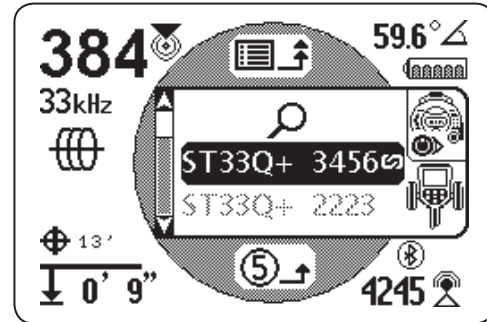

Once a connection is made, the transmitter automatically powers on. When connected, the Bluetooth icon  is visible on both the transmitter's and the receiver's screens. On the transmitter, a chain link image confirms that the two units are connected.







If the receiver has been paired with multiple transmitters, it automatically goes through the list and tries to connect to each one until it is successful.

*Note: The receiver can remember up to 16 devices it has been paired with. For more information on connecting to other devices, refer to the SR-24 manual.*

## Disconnecting the Devices

The two devices remain connected until manually disconnected. To disconnect the devices, follow these steps:

1. Make sure both the transmitter and receiver are powered on. On the receiver, press the Menu key .
2. Press the Down Arrow key  to navigate to and highlight the Bluetooth icon .
3. Press the Select key . The disconnect icon  displays when the devices have successfully disconnected.

On the transmitter, an image of a broken chain link confirms that the two units are disconnected.

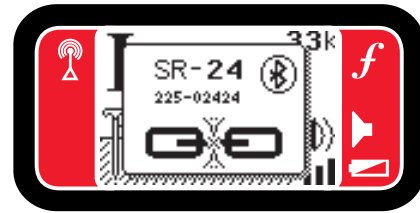

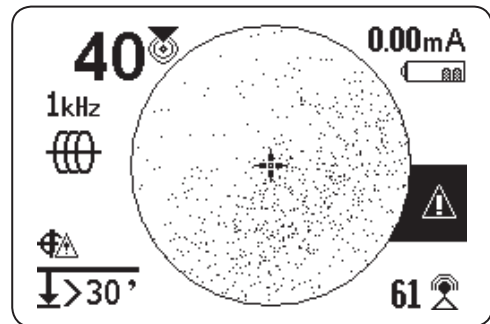

On the receiver, a warning alert displays.



## Powering the Transmitter

When the two units are connected with Bluetooth, powering the receiver on or off automatically powers the transmitter on or off.

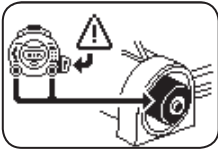
The receiver alerts you to changes in the transmitter's power status.

	<p>Switching to internal batteries.</p>
	<p>Powered off due to Power key press.</p>
	<p>Powered off due to low battery.</p>



## Setting the Frequency

Changing the receiver's frequency automatically updates the transmitter's frequency to match. If the frequency is changed on the transmitter, the receiver automatically updates to match as well.

## Transmitter Control Screen

When the devices are connected, you can see the transmitter's screen from the receiver. The transmitter control screen allows you to control the transmitter's frequency mode, choose between direct connect or inductive mode, and adjust output power remotely. You can also remotely power the transmitter on or off and know if the transmitter has powered off unexpectedly.

Any changes made on the transmitter to frequency, direct connect or inductive mode, and output power can be seen on the receiver.

To open the transmitter control screen on the receiver, press the Menu key , then press the Right Arrow key  to toggle in and out of the transmitter's control screen.

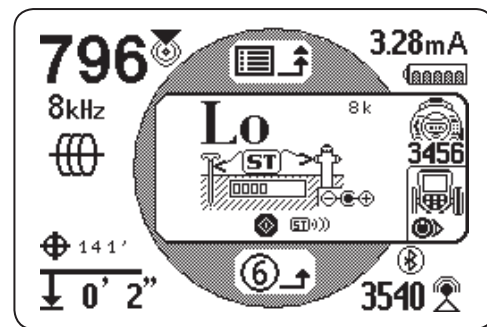

If more than one Bluetooth enabled SeekTech transmitter is present, press the Left Arrow key  to cycle through available transmitters. Press the serial number listed below the transmitter icon to identify the specific transmitter you want to control.

### Direct Connect Mode and Inductive Mode

To remotely set the transmitter to direct connect mode or inductive mode using the receiver, open the transmitter control screen. Press the Select key  to toggle between direct connect mode and inductive mode.

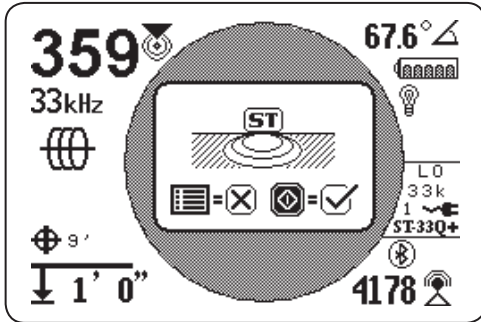



### Clamp Mode

The receiver can see the transmitter's clamp mode but cannot turn the transmitter's clamp mode on or off. An inductive clamp must be connected to access clamp mode. Refer to the operator's manual for your transmitter and inductive clamp for more information on using inductive clamp mode.

### Output Power

Higher output settings produce a stronger signal for the receiver, but reduces battery life for the transmitter. Only use 1,000 mA High Output Mode if using an 18 V Lithium-ion rechargeable battery, external power, or high capacity NiMH D cell batteries. Do not use the ST-33Q+ in high output mode with standard alkaline batteries.

You can read the transmitter's output power or change it remotely from the receiver. To remotely change the transmitter's output power using the receiver, open the transmitter control screen. Press the receiver's Up and Down Arrow keys   to adjust the output power.

WWW.RIDGID.COM

**Ridge Tool Company**  
400 Clark Street  
Elyria, Ohio 44035-6001  
U.S.

1-800-474-3443

**Ridge Tool Europe**  
Research Park Haasrode  
3001 Leuven  
Belgium

+ 32 (0)16 380 280

© 2014 Ridge Tool Company. All rights reserved.

Every effort has been made to ensure that the information in this manual is accurate. Ridge Tool Company and its affiliates reserve the right to change the specifications of the hardware, software, or both as described in this manual without notice. Visit [www.RIDGID.com](http://www.RIDGID.com) for current updates and supplemental information pertaining to this product. Due to product development, the photos and other presentations specified in this manual may differ from the actual product.

RIDGID and the RIDGID logo are trademarks of Ridge Tool Company, registered in the U.S. and other countries. All other registered and unregistered trademarks and logos mentioned herein are the property of their respective owners. Mention of third-party products is for informational purposes only and constitutes neither an endorsement nor a recommendation.

The Bluetooth word mark and logos are owned by the Bluetooth SIG, Inc.



**EMERSON. CONSIDER IT SOLVED.™**